

V50 Series 系列

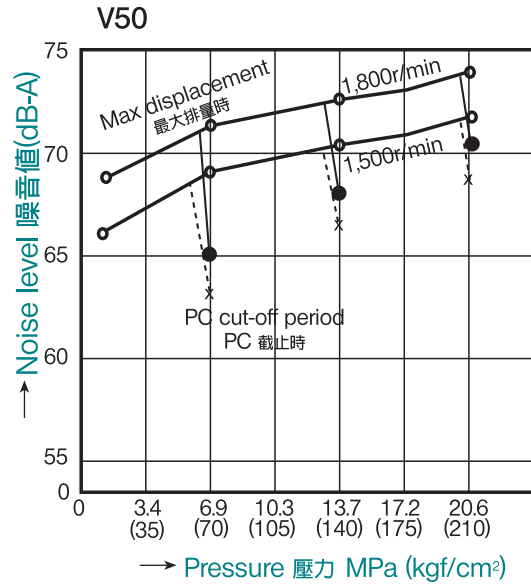

Typical performance characteristics 性能特性

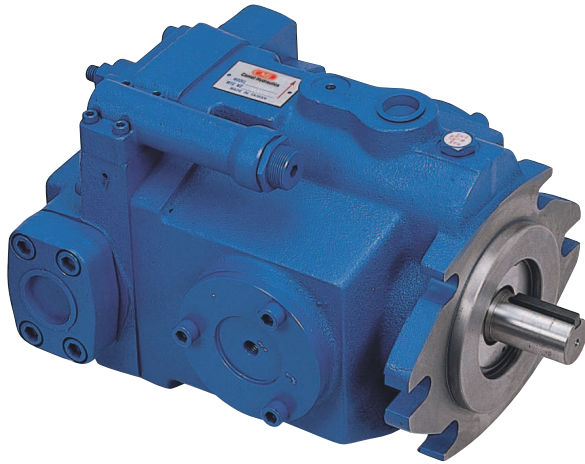
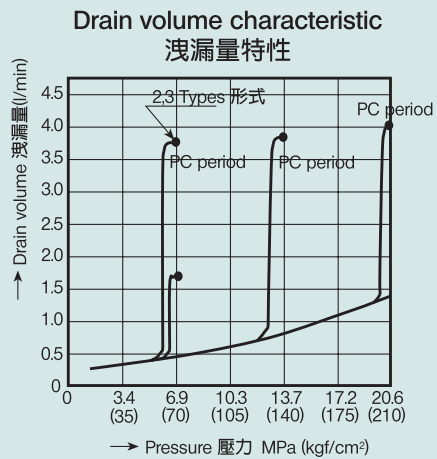
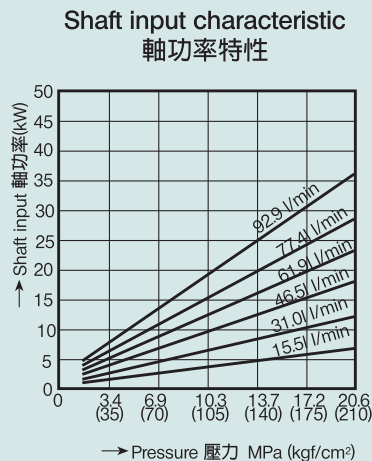
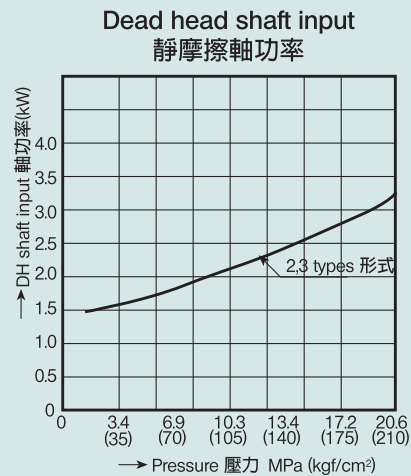
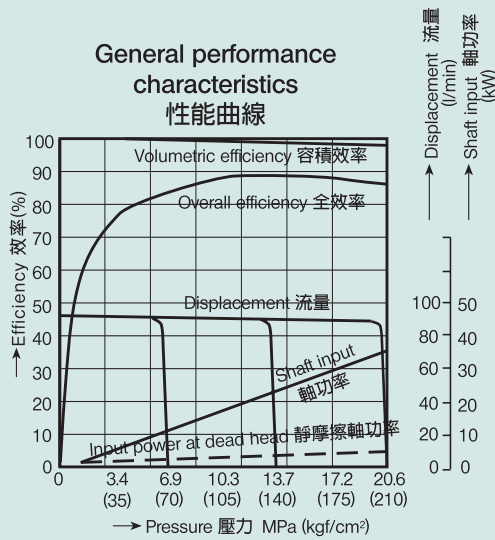

* Input speed 軸轉速 : 1,800r/min
 * Oil 使用油 : ISO VG32
 * Oil temperature 油溫 : 50°C

Unit 單位: mm

Dimensions 外型尺寸圖 : (Mounting Surface: SAE "C" 2-bolt & 4-bolt)

V50 A Type

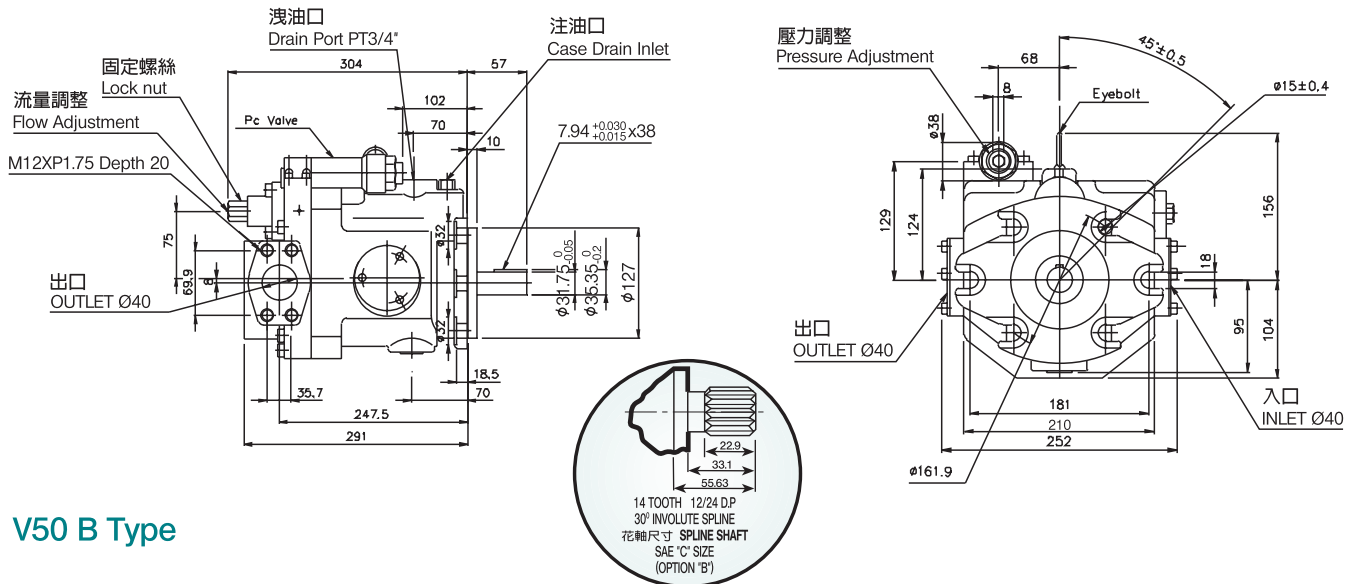

V50 B Type

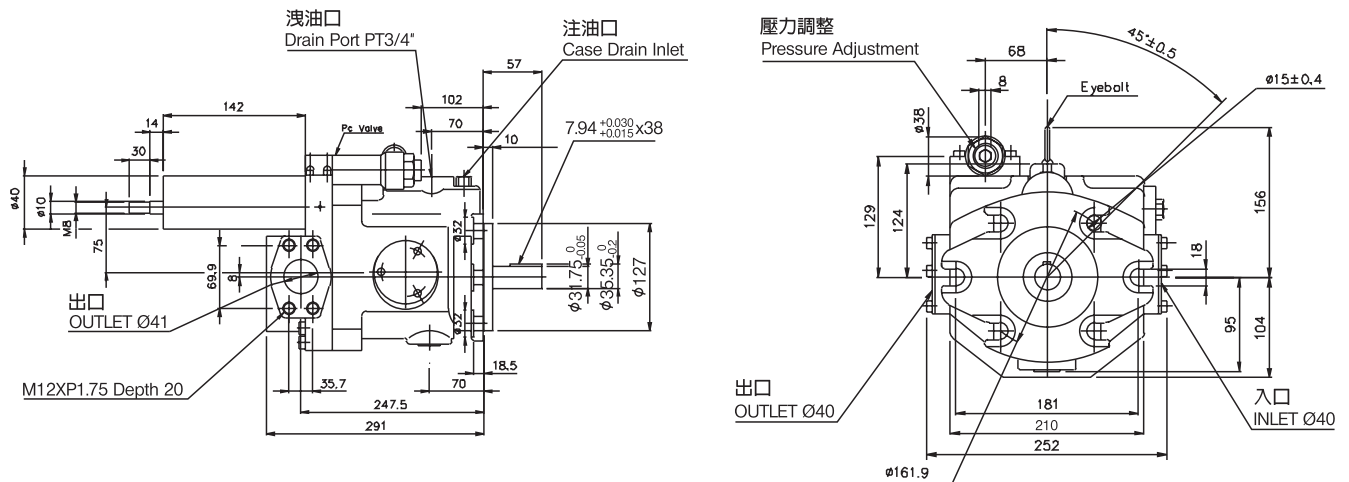

V50 G Type

