

EIPH 2
EIPH 3
EIPH 6

**INTERNAL GEAR
PUMPS**



- new Generation IPH
new technology
- up to 400 bar
- industrial version
- cast housing
- noise-optimized
- multi-flow-pumps
with common suc-
tion connection



Photo: Trumpf

Internal gear pump Type EIPH 2 with constant displacement volume



EIPH 2

Characteristics

- Internal gear pump with axial and radial gap compensation
- Radial compensation with segments
- Suction and pressure port radial
- Field of application: Industrial hydraulic
- Low noise
- Long time life
- Low pulsation (pressure pulsation ~ 2%)
- Multi flow combinations

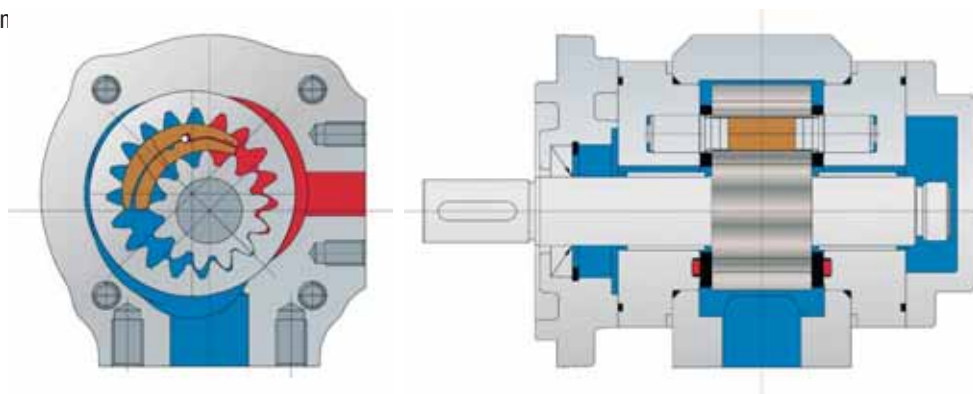

Technical Data:

Rated Size NG	004	005	006	008	011	013	016	019	022	025
Spec. volume V_{th} [cm ³ /rev.]***	3.8	5.4	6.4	7.9	10.9	13.3	15.8	19.3	22.2	25.2
Continuous operating pressure [bar]**	330							300	250	250
Peak operating pressure [bar] max.10 sec.15% duty cycle**	350							300	280	280
Cut-in pressure peak [bar]**	400							325	300	300
Max. speed [rpm]	4,200			4,000				3,600		
Nominal speed [rpm]	400 – 4,000			400 – 3,600				400 – 3,000		
Operating viscosity [mm ² /s]	10 – 300									
Starting viscosity [mm ² /s]	2,000									
Operating medium	HL – HLP DIN 51 524 part 1/2									
Max. medium temperature [°C]	80									
Min. medium temperature [°C]	-20									
Max. ambient temperature [°C]	80									
Min. ambient temperature [°C]	-20									
Max. admission pressure (intake side) [bar]	2 bar absolute									
Min. admission pressure (intake side) [bar]	0.8 bar absolute (Start 0.6)									
Weight appr. [kg]	4.9	4.9	5.0	5.2	5.4	5.5	5.7	6.1	6.3	6.5
Degree of filtration	Class 20/18/15 due to ISO 4406									

Efficiency η_{vol}	90	91	92	93	93	94	95	95	95	95
Efficiency η_{hm}	88	90	90	91	92	92	93	93	93	93
Pump noise* (measured in sound chamber) dB[A]	53	54	55	57	58	59	60	61	62	63
	n = 1.450		$\Delta p = 250$ bar		T = 50 °C		Medium: HLP 46			
	*Measured in anechoic room of Eckerle Hydraulic Division; Axial microphone distance 1.0 m									

** For acceptable pressure at 400-1.800 rpm. Further rpm on request.

*** Due to manufacturing tolerances the displacement volume could vary.

Internal gear pump Type EIPH 3 with constant displacement volume



EIPH 3

Characteristics

The new series EIPH were developed particularly for the high requirements of industrial hydraulics. Their favourable noise characteristic, extremely low delivery and pressure pulsation, outstanding efficiency within broad revolution and viscosity ranges, have firmly established gap-compensated high pressure internal gear pumps among high pressure pumps. Simple combinability to multiple pumps with separate or common inlet is given.

The EIPH... is a consistent advancement that already for over 40 years in the industry used gap-compensated internal gear pump technology, System Eckerle.

Technical Data:

Rated Size NG	014	016	020	025	032	040	050	064
Spec. volume V_{th} [cm ³ /rev.]***	14.6	16.0	20.0	24.8	32.1	40.1	50.3	64.6
Continuous operating pressure [bar]**	330			300			250	
Peak operating pressure [bar] max.10 sec.15% duty cycle**	350			300			280	
Cut-in pressure peak [bar]**	400			325			300	
Max. speed [rpm]	4,000		3,000		2,500		1,800	
Nominal speed [rpm]	400 – 3,600		400 – 2,800		400 – 2,200		400 – 1,800	
Operating viscosity [mm ² /s]	10 – 300							
Starting viscosity [mm ² /s]	2,000							
Operating medium	HL – HLP DIN 51 524 part 1/2							
Max. medium temperature [°C]	80							
Min. medium temperature [°C]	-20							
Max. ambient temperature [°C]	80							
Min. ambient temperature [°C]	-20							
Max. admission pressure (intake side) [bar]	2 bar absolute							
Min. admission pressure (intake side) [bar]	0.8 bar absolute (Start 0.6)							
Weight appr. [kg]	13.1	13.2	13.4	13.5	13.7	16.4	17.5	19.5
Degree of filtration	Class 20/18/15 due to ISO 4406							

Efficiency η_{vol}	91	92	93	93	94	95	95	95
Efficiency η_{hm}	90	90	91	92	92	93	93	93
Pump noise* (measured in sound chamber) dB[A]	60	61	62	63	64	65	66	66
	n = 1.450		$\Delta p = 250$ bar		T = 50 °C		Medium: HLP 46	
	*Measured in anechoic room of Eckerle Hydraulic Division; Axial microphone distance 1.0 m							

** For acceptable pressure at 400-1.800 rpm. Further rpm on request.

*** Due to manufacturing tolerances the displacement volume could vary.

Internal gear pump
Type EIPH 6
with constant displacement volume



EIPH 6

Technical Data:

Rated Size NG	040	050	064	080	100	125	160	200	250
Spec. volume V _{th} [cm ³ /rev.]***	40,8	50,6	65,3	80,0	101,2	125,7	160,1	200,9	249,9
Continuous operating pressure [bar]**	330		315	300		280		250	210
Peak operating pressure [bar] max. 10sec 15% duty cycle**	340		330	330		300		270	250
Cut-in pressure peak [bar]**	350		340	340		320		300	250
Max. speed [rpm]	2.400			2.200			2.000		
Nominal speed [rpm]	400 – 2.200			400 – 2.000			400 – 1.800		
Operating viscosity [mm ² /s]	10 – 300								
Starting viscosity [mm ² /s]	2.000								
Operating medium	HL – HLP DIN 51 524								
Max. medium temperature [°C]	80								
Min. medium temperature [°C]	-20								
Max. ambient temperature [°C]	80								
Min. ambient temperature [°C]	-20								
Max. admission pressure (intake side) [bar]	2 bar absolute								
Min. admission pressure (intake side) [bar]	0,8 bar absolute								
Weight appr. [kg]:	23	25	28	31	36	41,5	49	58	69
Degree of filtration	Class 20/18/15 due to ISO 4406								

Efficiency η_{vol}	96	96	96	95	95	94	94	93	93
Efficiency η_{hm}	89		90		91				
Pump noise* (measured in sound chamber) dB[A]	72	73	74	75	76	76	77	77	78
	n = 1.450		$\Delta p = 250$ bar		T = 50 °C		Medium: HLP 46		
	*Measured in anechoic room of Eckerle Hydraulic Division; Axial microphone distance 1.0 m								

** For acceptable pressure at 400-1.800 rpm. Further rpm on request.

*** Due to manufacturing tolerances the displacement volume could vary.



Pump with 2-hole flange

Order example: EIPH2- ___ RK03-1X

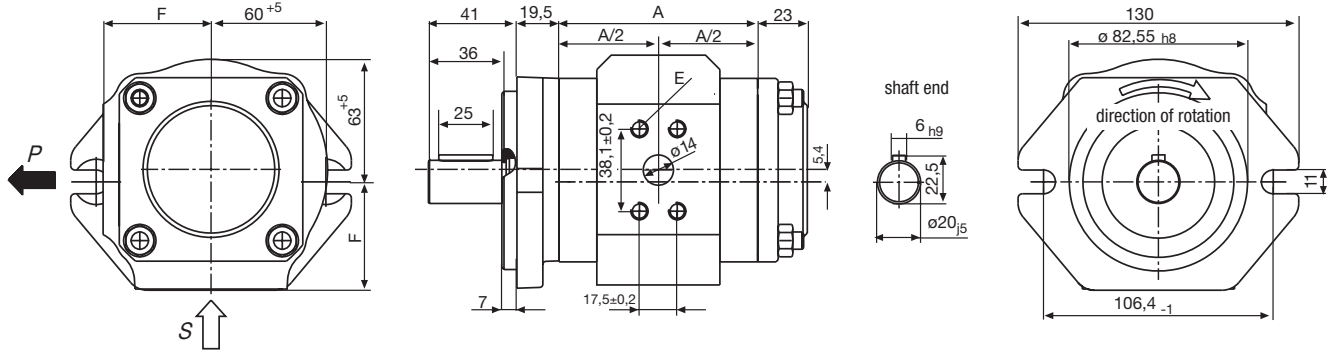

NG	A	B	C	D	E	F
004	71	14	38.1	17.5	M8x13 deep	50
005	71	14	38.1	17.5	M8x13 deep	50
006	73	19	47.5	22.0	M10x15 deep	50
008	76	19	47.5	22.0	M10x15 deep	50
011	82	25	52.4	26.2	M10x15 deep	50
013	87	25	52.4	26.2	M10x15 deep	50
016	92	25	55.4	26.2	M10x15 deep	50
019	99	25	55.4	26.2	M10x15 deep	55.1
022	105	25	55.4	26.2	M10x15 deep	55.1
025	111	25	55.4	26.2	M10x15 deep	55.1

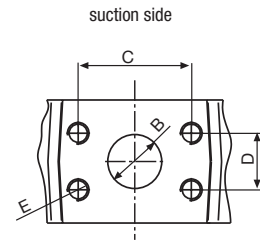

Double Pump with SAE-B-2-hole flange and cylindrical shaft

Order example: EIPH2- ___ RK03-1X

EIPH2- ___ RP33-1X

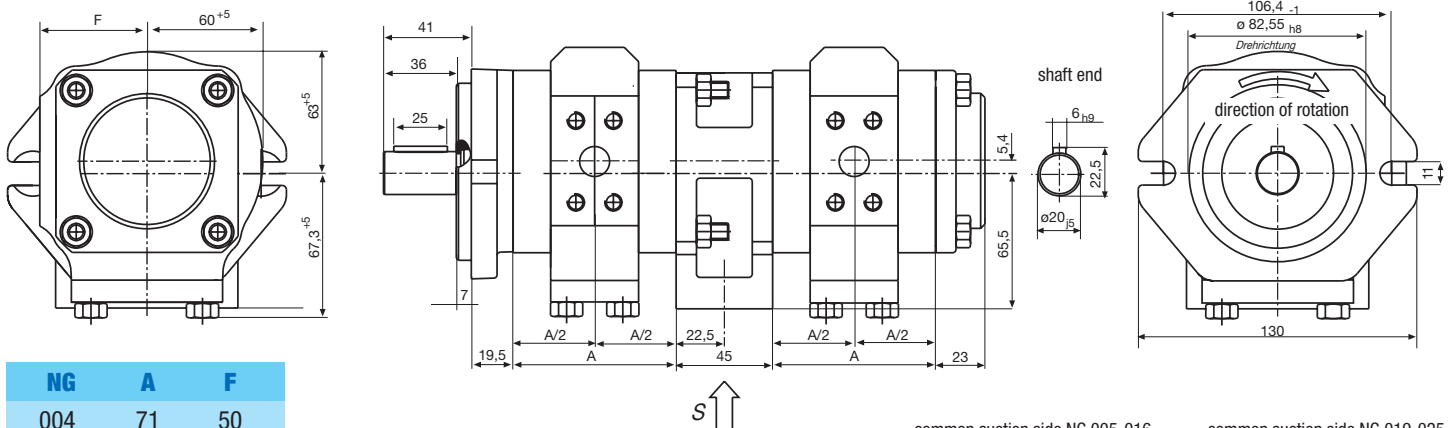

NG	A	F
004	71	50
005	71	50
006	73	50
008	76	50
011	82	50
013	87	50
016	92	50
019	99	55.1
022	105	55.1
025	111	55.1

common suction side NG 005-016

common suction side NG 019-025

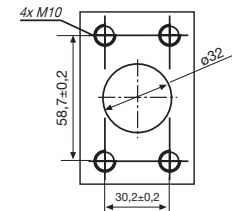
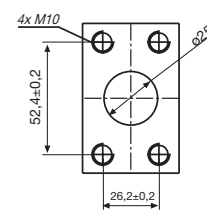

Pressure connection see single pump



Pump with 2-hole flange

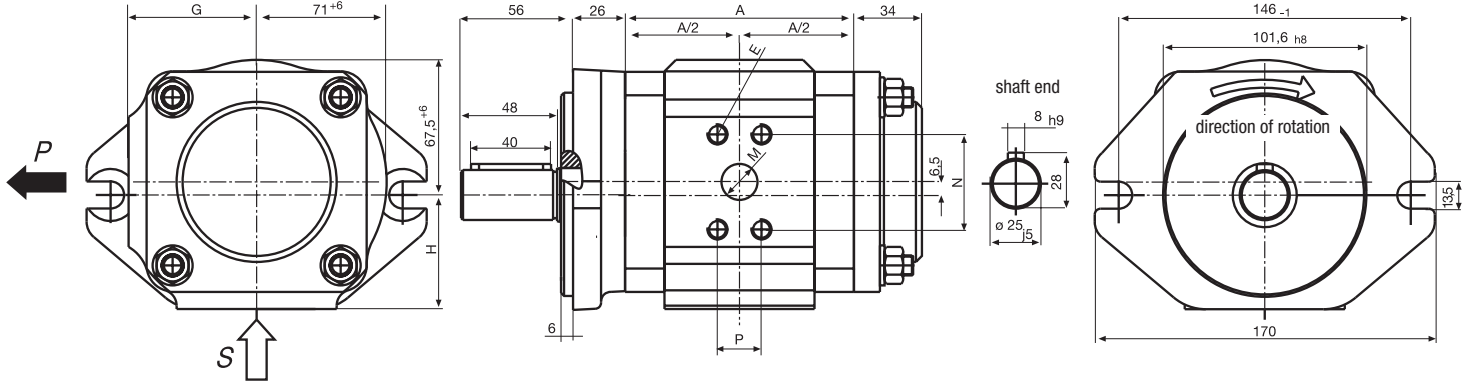

Order example: EIPH3-___RK23-1X

NG	A	B	C	D	E	M	N	P	G	H
014	88.4	25	52.4	26.2	M8	14	38.1	17.5	64	57
016	92.4	25	52.4	26.2	M8	14	38.1	17.5	64	57
020	97.8	32	58.7	30.2	M10	18	47.5	22	64	57
025	104.4	32	58.7	30.2	M10	18	47.5	22	64	57
032	114.4	32	58.7	30.2	M10	18	47.8	22	64	57
040	125.4	32	58.7	30.2	M10	20	52.4	26.2	70	63
050	139.4	32	58.7	30.2	M10	20	52.4	26.2	70	63

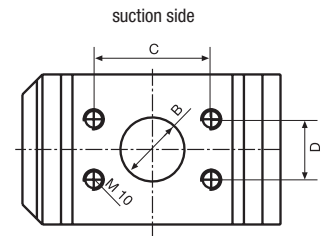

Double Pump with SAE-B-2-hole flange and cylindrical shaft

Order example: EIPH3-___RK23-1X
EIPH3-___RP33-1X

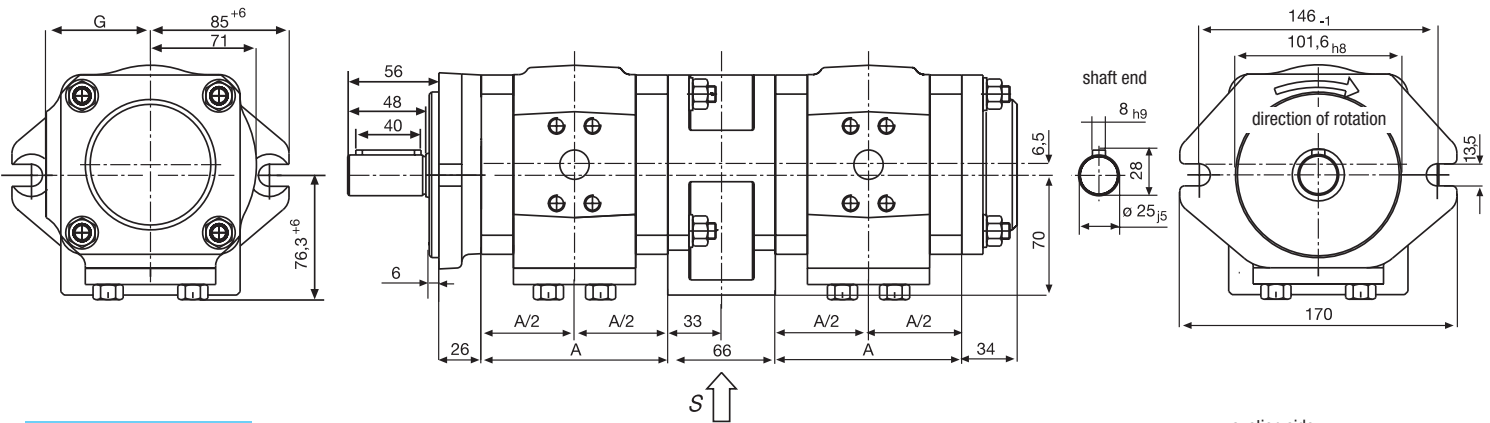

NG	A	G
014	88.4	64
016	92.4	64
020	97.8	64
025	104.4	64
032	114.4	64
040	125.4	70
050	139.4	70

Pressure connection see single pump

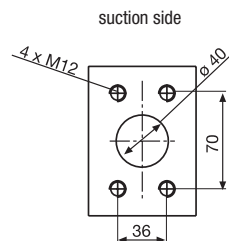



Double Pump with SAE-B-2-hole flange and cylindrical shaft

Order example: EIPH3-__RK23-1X
EIPH2-__RP33-1X

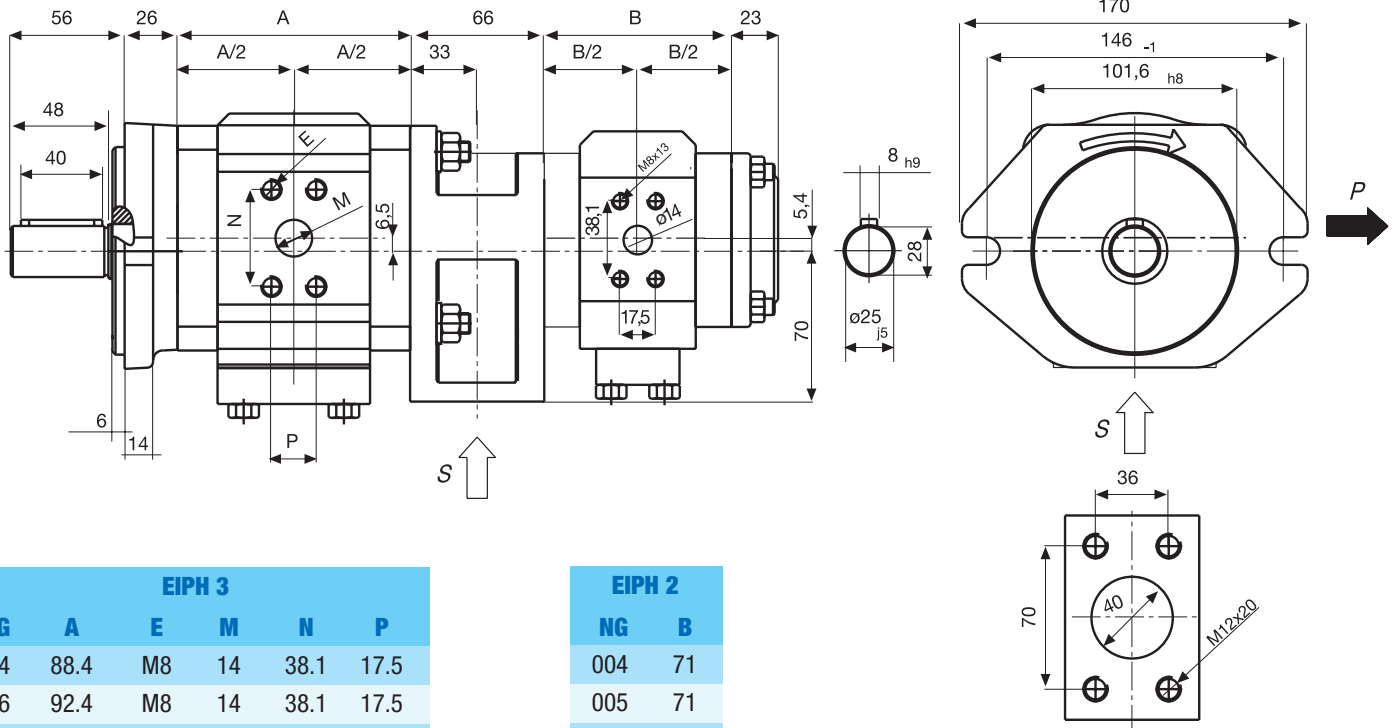

EIPH 3					
NG	A	E	M	N	P
014	88.4	M8	14	38.1	17.5
016	92.4	M8	14	38.1	17.5
020	97.8	M10	18	47.5	22
025	104.4	M10	18	47.5	22
032	114.4	M10	18	47.5	22
040	125.4	M10	20	52.4	26.2
050	139.4	M10	20	52.4	26.2

EIPH 2	
NG	B
004	71
005	71
006	73
008	76
011	82
013	87
016	92
019	99
022	105
025	111



Pump with SAE-C-2-hole flange and cylindrical shaft

Order example: EIPH6-___RK23-1X

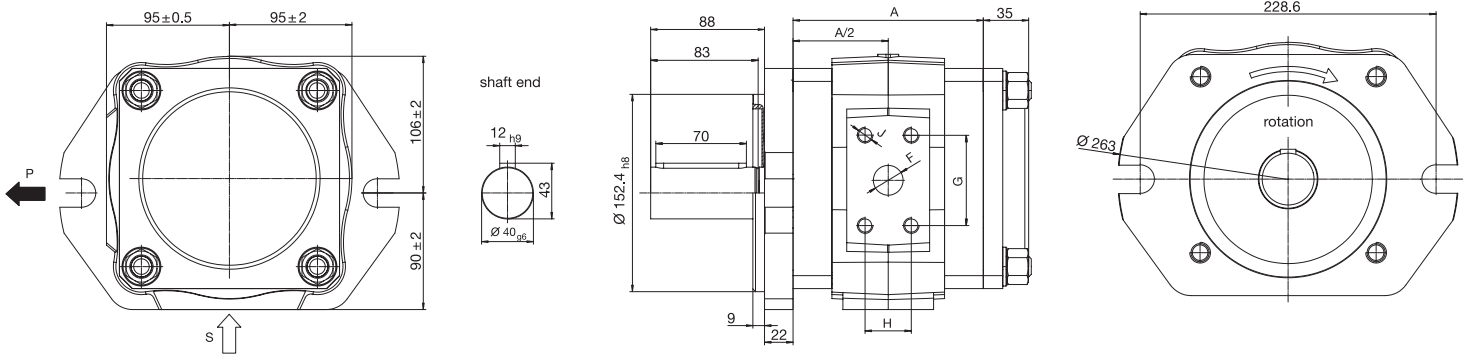

NG	A	B	C	D	E	F	G	H	J
040	123	35	69,9	35,7	M12x25	20	57,2	27,8	M12x22
050	129	40	69,9	35,7	M12x25	20	57,2	27,8	M12x22
064	138	40	69,9	35,7	M12x25	20	57,2	27,8	M12x22
080	147	50	77,8	42,9	M12x25	30	66,7	31,8	M14x25
100	160	50	77,8	42,9	M12x25	30	66,7	31,8	M14x25
125	175	50	77,8	42,9	M12x25	30	66,7	31,8	M14x25
160	220	65	88,9	50,8	M12x25	30	66,7	31,8	M14x25

Double Pump with SAE-C-2-hole flange and cylindrical shaft

Order example: EIPH6-___RK20-1X
EIPH6-___RP30-1X

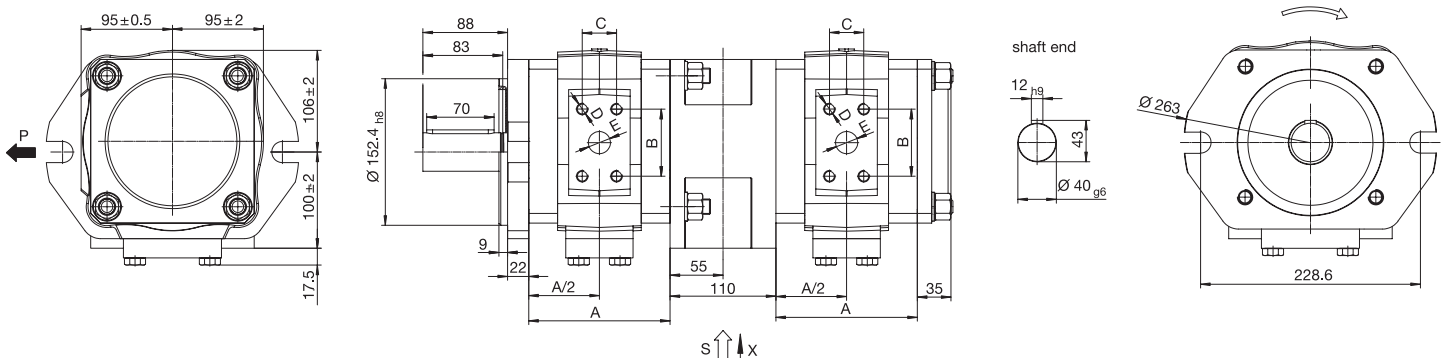

NG	A	B	C	D	E
040	123	57,2	27,8	M12x22	20
050	129	57,2	27,8	M12x22	20
064	138	57,2	27,8	M12x22	20
080	147	66,7	31,8	M14x25	30
100	160	66,7	31,8	M14x25	30
125	175	66,7	31,8	M14x25	30
160	220	66,7	31,8	M14x25	30

X: Common suction port

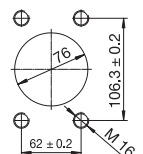



Double Pump with SAE-C-2-hole flange and cylindrical shaft

Order example: EIPH6- ___ RK20-1X
EIPH3- ___ RP30-1X

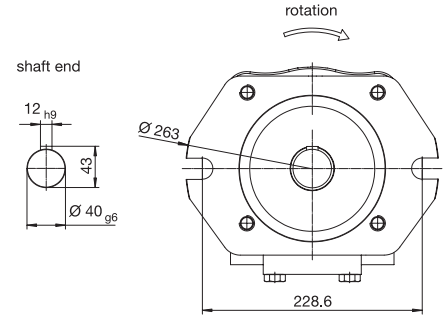
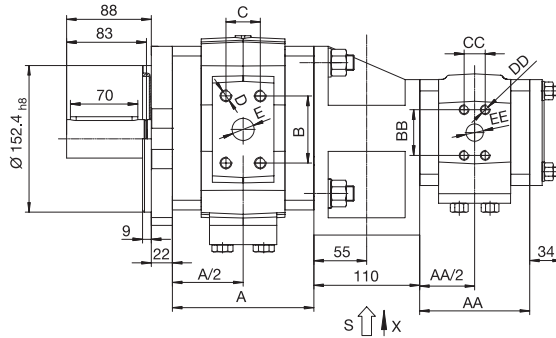
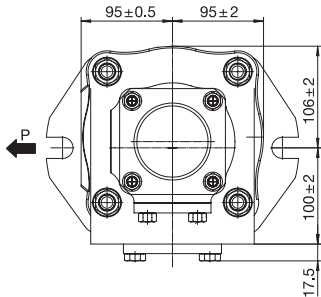

EIPH6

NG	A	B	C	D	E
040	123	57,2	27,8	M12x22	20
050	129	57,2	27,8	M12x22	20
064	138	57,2	27,8	M12x22	20
080	147	66,7	31,8	M14x25	30
100	160	66,7	31,8	M14x25	30
125	175	66,7	31,8	M14x25	30
160	220	66,7	31,8	M14x25	30

EIPH3

NG	AA	BB	CC	DD	EE
014	88,4	38,1	17,5	M8	14
016	92,4	38,1	17,5	M8	14
020	97,8	47,5	22	M10	18
025	104,4	47,5	22	M10	18
032	114,4	47,5	22	M10	18
040	125,4	52,5	26,2	M10	20
050	139,4	52,5	26,2	M10	20

X: Common suction port

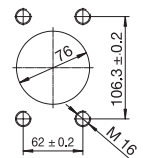

Double Pump with SAE-C-2-hole flange and cylindrical shaft

Order example: EIPH6- ___ RK20-1X
EIPH2- ___ RP30-1X

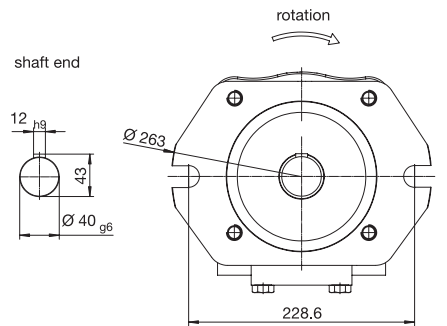
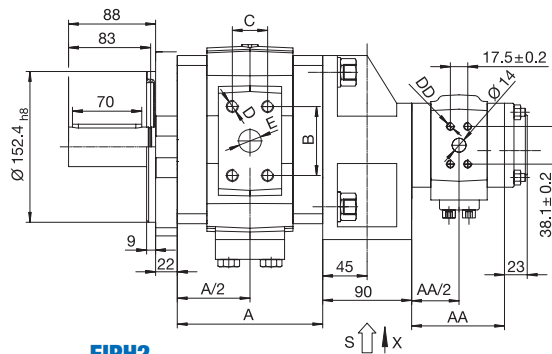
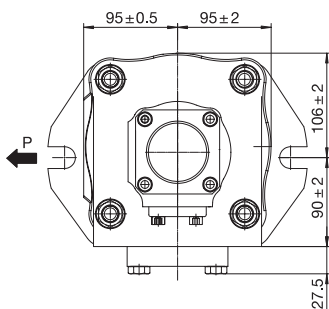

EIPH6

NG	A	B	C	D	E
040	123	57,2	27,8	M12x22	20
050	129	57,2	27,8	M12x22	20
064	138	57,2	27,8	M12x22	20
080	147	66,7	31,8	M14x25	30
100	160	66,7	31,8	M14x25	30
125	175	66,7	31,8	M14x25	30
160	220	66,7	31,8	M14x25	30

EIPH2

NG	AA	DD	FF	GG	HH
004	71	M8	50	54	57
005	71	M8	50	54	57
006	73	M10	50	54	57
008	76	M10	50	54	57
011	82	M10	50	54	57
013	87	M10	50	54	57
016	92	M10	50	54	57
019	99	M10	55	59	62
022	105	M10	55	59	62
025	111	M10	55	59	62

X: Common suction port

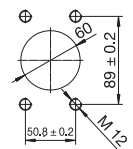



SAE flange metric tapped



Version a

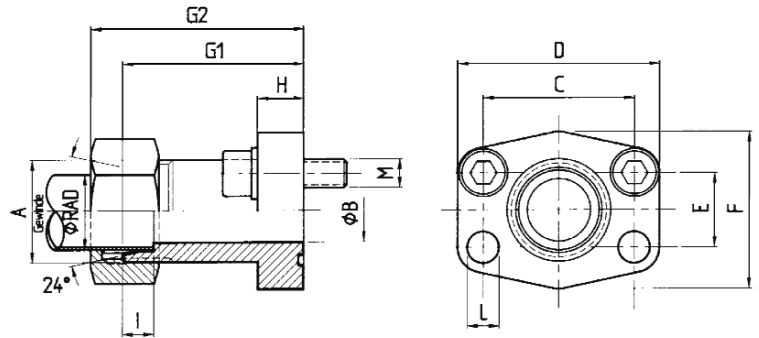

SAE pipe threaded flange



Version b

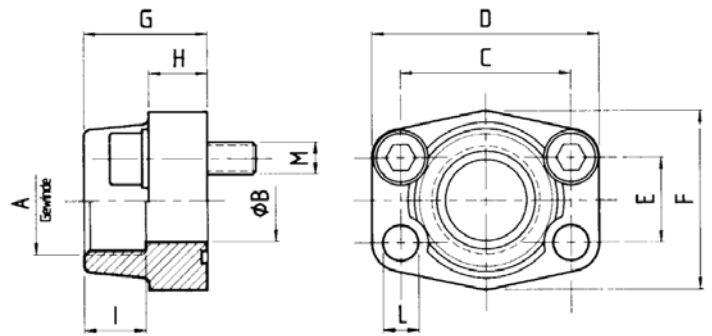

Nr.	Article number	Type	P _{max}	AD	A	B	C	D	E	F	G1	G2	H	I	L
1a	07 07 04 0030	AD15-SAE12M22x1,5	315	15	M22x1,5	12	38,1	54	17,48	46	52	60	13	7	9
1b	07 07 04 0026	EFG1/2-SAE12	350		G1/2"	13	38,1	54	17,48	46	36		19	19	9
2a	07 07 04 0031	AD22-SAE34M30x2	160	22	M30x2	19	47,63	65	22,23	50	60	69	14	7,5	11,5
2b	07 07 04 0027	EFG3/4-SAE34	350		G3/3"	19	47,63	65	22,23	50	36		18	19	11
3a	07 07 04 0032	AD28-SAE100M36x2	160	28	M36x2	24	52,37	70	26,19	55	63	72	16	7,5	11,5
3b	07 07 04 0028	EFG1-SAE100	315		G1"	25	52,37	70	26,19	55	38		18	22	11
4a	07 07 04 0033	AD35-SAE114M45x2	160	35	M45x2	29	58,72	79	30,18	68	65	76	14	10,5	11,5
4b	07 07 04 0029	EFG1 1/4-SAE114	250		G1 1/4"	32	58,72	79	30,18	68	41		21	22	11,5
5a	07 07 04 0037	AD42-SAE112M52x2	160	42	M52x2	36	69,85	94	35,71	78	70	82	16	11	13,5
5b	07 07 04 0034	EFG1 1/2-SAE112	200		G1 1/2"	38	69,85	94	35,71	78	45		25	24	13,5
6b	07 07 04 0036	EFG2-SAE200	200		G2"	51	77,77	102	42,88	90	45		25	30	13,5
7b	07 07 04 0041	EFG2 1/2-SAE212	160		G2 1/2"	63	88,9	114	50,8	105	50		25	30	13,5
8a	07 07 04 0042	AD30-SAE100M42x2HD	400	30	M42x2	25	57,2	81	27,8	70	82	95	24	13,5	13
9a	07 07 04 0043	AD38-SAE114M52x2HD	400	38	M52x2	32	79,38	113	36,5	95	96	111	30	16	17,5



SAE Pressure- and Suction flange SAE J518C, ISO 6162

Type	Inlet	Nr.	Version		Outlet	Nr.	Version	
			a	b			a	b
EIPH2-004-005	1/2"	1	•	•	1/2"	1	•	•
EIPH2-006-008	3/4"	2	•	•	1/2"	1	•	•
EIPH2-011-025	1"	3	•	•	1/2"	1	•	•
EIPH3-014-016	1"	3	•	•	1/2"	1	•	•
EIPH3-020-032	1 1/4"	4	•	•	3/4"	2	•	•
EIPH3-040-064	1 1/4"	4	•	•	1"	3	•	•
EIPH6-040-064	1 1/2"	5	•	•	1" *	8	•	
EIPH6-080-125	2"	6		•	1 1/4" *	9	•	
EIPH6-160	2 1/2"	7		•	1 1/4" *	9	•	

*High pressure range

Suction flange for Intermittent housing

Type	Inlet	Nr.	Version	
			a	b
EIPH2/2 - NG016	1"	3	•	•
EIPH2/2 ab NG0191	1/4"	4	•	•
EIPH3/3 bis NG0321	1/2"	5	•	•
EIPH3/3 ab NG040	2"	6		•
EIPH6/6			○	○
EIPH6/3			○	○
EIPH6/2			○	○

• = available ○ = on request



EIP H2 - 016 RK03 - 10 S123

Special version number (not applicable with standard pumps or when the type key is unambiguous)

Revision code 1st number: Change of mounting dimensions
2nd number: Change of pump with same mounting dimensions

Intake and delivery connection 3: SAE-flange connections
– other flanges on request –
0: suction port closed; common inlet

Fastening flange 0: SAE/A 2-hole flange, centre-Ø 82.55
2: SAE/B 2-hole flange, centre-Ø 101.6 / at EIPH6 Ø152,4
3: Direkt fixture
5: VDMA on demand
– other flanges on request –

Shaft end K: Cylindrical with cone
P: Cone tooth system on both sides
cone is standard;
(cone = add-on facility for additional pumps to create multiple-flow pumps)

Sense of rotation R: Clockwise
L: Anticlockwise

Rated size, three digits

Overall size 2 or 3 or 6

Type H: High pressure pump

Eckerle internal gear pump

Order example

EIPH2 - 016 RK03 - 1X

High pressure pump
overall size 2 with 15,8 cm³/U
clockwise rotation
cylindrical shaft with cone
SAE/B-2-hole flange connection
SAE flange connection
revision code 10