

# ConCar

POWER TRANSMISSION SYSTEMS

Industrie-  
riemen

Industrial  
Belts

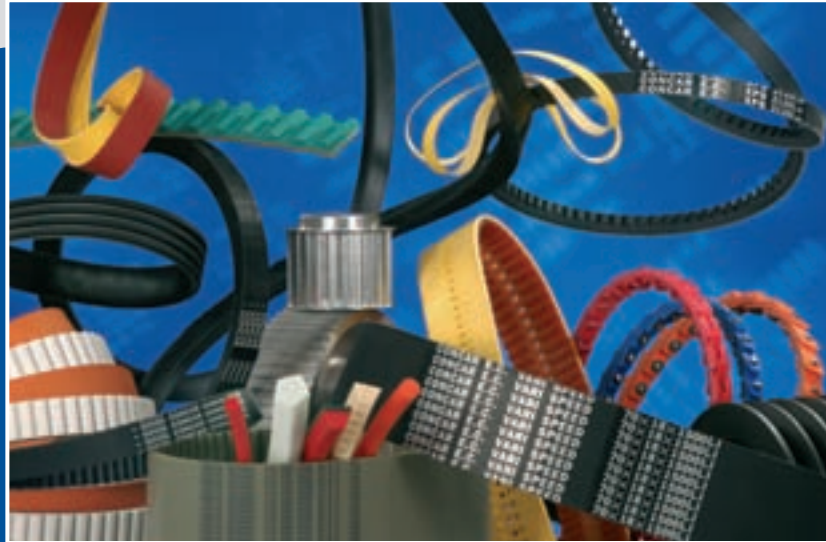

Brutto-Preisliste  
Gross Price List

# 2007

Gültig ab / Effective from  
01.03.2007

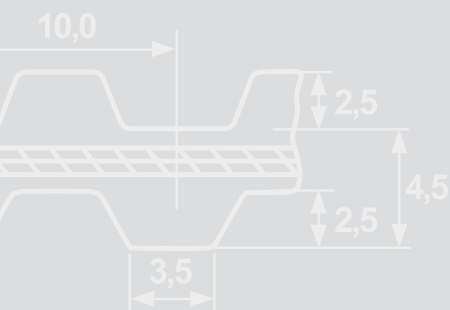
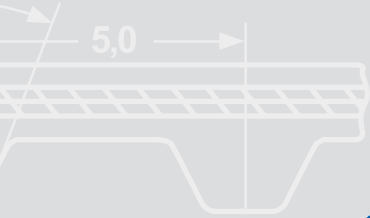

## Keilriemen / V-belts

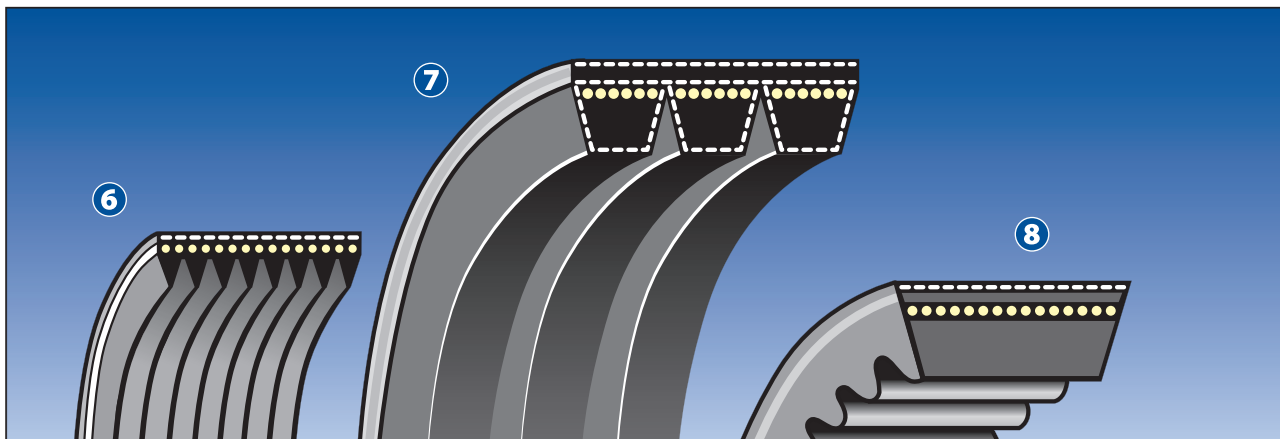
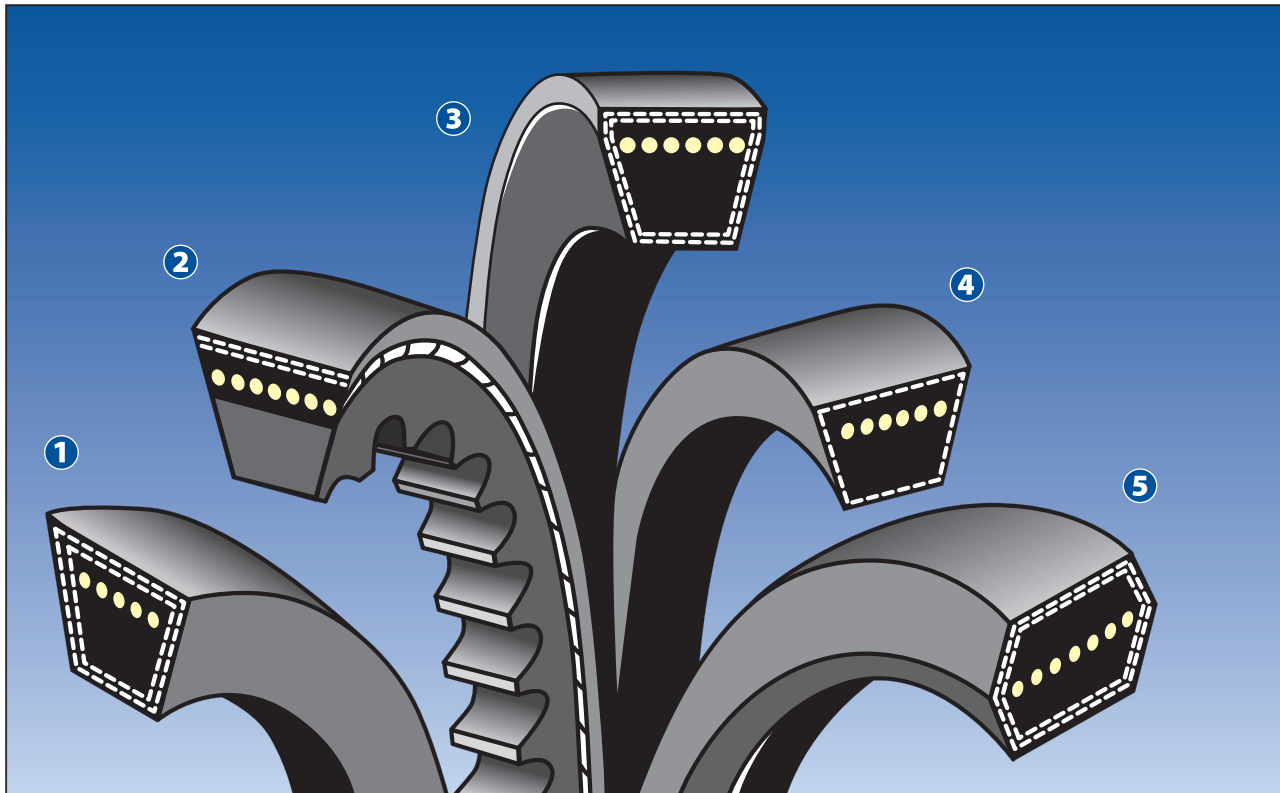

- |  |  |
|--|--|
| <p><b>1</b> Ummantelte Schmalkeilriemen (DIN 7753)<br/>           Wrapped narrow V-belts (DIN 7753)</p> <p><b>2</b> Flankenoffene Hochleistungs-Schmalkeilriemen (DIN 7753)<br/>           High performance narrow V-belts (DIN 7753)</p> <p><b>3</b> Ummantelte Schmalkeilriemen nach US-Norm RMA/MPTA<br/>           Wrapped V-belts acc. US norm RMA/MPTA</p> | <p><b>6</b> Keilrippenriemen<br/>           Ribbed belts</p> <p><b>7</b> Kraftbänder<br/>           Banded belts</p> <p><b>8</b> Breitkeilriemen<br/>           Variable speed belts</p> |
| <p><b>4</b> Klassische ummantelte Keilriemen (DIN 2215)<br/>           Classical wrapped V-belts (DIN 2215)</p> <p><b>5</b> Doppelkeilriemen (DIN 7722)<br/>           Double V-belts (DIN 7722)</p>   |  |

# ConCar



**ConCar** ist ein Spezialist im Bereich Antriebs- und Förderriemen aus Gummi und Kunststoff. Seit fast 30 Jahren werden diese Riemen unter der Handelsmarke **ConCar** in Deutschland und weltweit vermarktet.

**ConCar** entwickelt, veredelt und produziert in Kooperation mit namhaften Herstellern in Westeuropa, Japan und den USA Antriebs- und Förderriemen für die Industrie, Kraftfahrzeuge, Landwirtschaft und Bergbau.

Unsere langjährige Erfahrung ermöglicht es, unseren Kunden eine umfangreiche technische Beratung sowie individuelle Problemlösungen anzubieten. Für besondere Anwendungsfälle werden Riemen in speziellen Qualitäten und Ausführungen gefertigt.

**ConCar** unterhält im Zentrallager Hohenkammer bei München ein umfangreiches Sortiment von über 500 000 Riemen und Scheiben. Hohe Verfügbarkeit und eine breite Produktpalette sind die Stärken, die es **ConCar** erlauben, auf jeden Bedarfsfall flexibel zu reagieren.



**ConCar** is a specialist in the field of power transmission- and conveyor belts made of rubber or plastic. For almost 30 years these belts are commercialised in Germany and world-wide with the trade mark **ConCar**.

**ConCar** develops, finishes and produces, in co-operation with very well-known manufacturers in Western Europe, Japan and the USA, power transmission- and conveyor belts in top quality for industry, automobiles, agricultural and mining.

Our experience of many years enables us to offer our customers an extensive technical consultation, as well as solutions of problems. This constellation is the reason why **ConCar** is able to deliver the proper belt in every case.

**ConCar** keeps an extensive assortment of more than 500,000 belts and pulleys in the warehouse in Hohenkammer near Munich. The special flexibility of **ConCar** is secured by a wide product range and permanent availability of the products.

<b><u>Keilriemen</u></b>		Seite
Breitkeilriemen	Vari-Speed - flankenoffen, formgezahnt.....	29 - 30
	USA - Standard - flankenoffen, formgezahnt.....	31
Doppelkeilriemen	ummantelt.....	22
GardenPower	Kupplungsriemen.....	34 - 35
Gliederkeilriemen	Meterware.....	36
Klassische Keilriemen	ummantelt, DIN 2215 / ISO 4184.....	15 - 21
	REX - flankenoffen, formgezahnt.....	27 - 28
Keilrippenriemen	Neoprene, Polyurethan.....	39 - 40
Kraftbänder	Verbundkeilriemen ummantelt.....	32 - 33
Lochkeilriemen	endlich, grün, DIN 2216.....	36
Polyurethan Keilriemen	Meterware, 80 - 100° Shore A.....	109 - 110
Schmalkeilriemen	ummantelt, DIN 7753 / ISO 4184.....	12 - 13
	USA - Standard RMA/ MPTA.....	14
	REX - flankenoffen, formgezahnt.....	23 - 24
	Quad-Power II.....	25 - 26
Weitwinkelkeilriemen	Polyurethan, 60° Winkel, Einzel-KR/ Verbund-KR.....	37 - 38
<b><u>Zahnflachriemen</u></b>		
HTD / RPP - Zahnflachriemen	Neoprene, einfach gezahnt, metrisch.....	56 - 62
	Neoprene, doppelt gezahnt, metrisch.....	63 - 65
	Neoprene, RPP Silver.....	66 - 69
	Neoprene, RPP Gold mit Glasfaser - Zugstrang.....	70 - 71
Neoprene Zahnflachriemen	Eagle.....	87
	Falcon.....	74
	einfach gezahnt, zöllig.....	41 - 51
	doppelt gezahnt, zöllig.....	51 - 55
	Long Length HTD-Meterware.....	104
Meterware, zöllig.....	105	
Polyurethan - Zahnflachriemen	Poly Chain.....	72 - 73
	einfach gezahnt mit Stahllitzen, metrisch.....	88 - 93
	doppelt gezahnt mit Stahllitzen, metrisch.....	94
	einfach gezahnt mit Stahllitzen, zöllig.....	95 - 97
	Meterware - endlich und endlos verschweißt.....	98 - 103
Flex mit endlos gespulten Stahllitzen.....	106	
STS / STD - Zahnflachriemen	Neoprene, einfach gezahnt, metrisch.....	75 - 81
	Neoprene, doppelt gezahnt, metrisch.....	82 - 86

### Flachriemen

Neoprene - Flachriemen	endlos gewebt.....	106
Polyurethan - Flachriemen	endlos gewebt.....	107

### Rundriemen

Rundriemen	Polyurethan, Meterware, 80 - 100° Shore A.....	109 - 110
Verbindungswerkzeuge	.....	108

### Sonstiges

Lieferbedingungen.....	8
Sonderausführungen und technische Daten.....	9 - 11

<b><u>V - Belts</u></b>		Page
Banded - Belts	team - belts, wrapped.....	32 - 33
Classical Section V - Belts	wrapped , DIN 2215 / ISO 4184.....	15 - 21
	REX - raw edge, moulded cogged.....	27 - 28
Double V - Belts	wrapped, hexagonal.....	22
GardenPower	belts for clutching drives	34 - 35
Link - Belts	open ended.....	36
Narrow V - Belts	wrapped, DIN 7753 / ISO 4184.....	12 - 13
	USA - Standard RMA/ MPTA.....	14
	REX - raw edge, moulded cogged.....	23 - 24
	Quad Power II.....	25 - 26
Polyurethane V - Belts	open ended, 80 - 100° Shore A.....	109 - 110
Punched Belts	open ended, green, DIN 2216.....	36
Ribbed Belts	Neoprene, Polyurethane.....	39 - 40
Variable Speed Belts	Vari-Speed - raw edge, moulded cogged.....	29 - 30
	USA - Standard - raw edge, moulded cogged.....	31
Wide Angle Belts	Polyurethane, 60° angle, single/ banded.....	37 - 38
<b><u>Timing Belts</u></b>		
HTD / RPP - Timing Belts	Neoprene, single toothed, metric.....	56 - 62
	Neoprene, double toothed, metric.....	63 - 65
	Neoprene, RPP Silver.....	66 - 69
	Neoprene, RPP Gold with fibreglass cord.....	70 - 71
Neoprene Timing - Belts	Eagle.....	87
	Falcon.....	74
	single toothed, inch.....	41 - 51
	double toothed, inch.....	51 - 55
	Long Length HTD-open ended	104
	open ended, inch.....	105
Polyurethane Timing - Belts	Poly Chain	72 - 73
	single toothed with steel cord, metric.....	88 - 93
	double toothed with steel cord, metric.....	94
	single toothed with steel cord, inch.....	95 - 97
	open ended and jointed.....	98 - 103
Flex with endless spooled steel cord.....	106	
STS / STD Timing Belts	Neoprene, single toothed, metric.....	75 - 81
	Neoprene, double toothed, metric.....	82 - 86

### **Flat Belts**

Neoprene - Flat Belts	endless woven.....	106
Polyurethane - Flat Belts	endless woven.....	107

### **Round Belts**

Round Belts	Polyurethane, open ended, 80 - 100° Shore A.....	109 - 110
FittingTools	.....	108

### **Sundries**

Delivery terms.....	8
Special constructions and technical data.....	9 - 11

### Lieferbedingungen

Die Mindestbestellmenge beträgt je Inlandsauftrag EUR 50.- netto.

Lieferungen unter EUR 50.- werden mit EUR 10.- Mindermengenzuschlag berechnet.

Die Lieferungen erfolgen je Inlandsauftrag ab einem Warenettowert von EUR 50.- frei Haus inklusive Verpackung. Darunter unfrei ab Werk exklusive Verpackung.

Die Mindestbestellmenge beträgt je Exportauftrag EUR 125.- Warenettowert.

Die Preise verstehen sich unfrei ab Werk inklusive Verpackung.

Die hier aufgeführten Preise verstehen sich für Inlandsaufträge zuzüglich der gültigen Mehrwertsteuer.

Alle früheren Preislisten werden hiermit ungültig. Die Preise sind freibleibend.

Es gelten unsere Allgemeinen Geschäftsbedingungen.

### Terms of delivery

Minimum value of export orders is EUR 125.- net value.

Prices of goods are ex works incl. packing.

All former price lists are invalid.

Our general terms of business are valid.

## Sonderausführungen und technische Daten Special constructions and technical data

**ConCar** liefert Spitzenprodukte der Antriebs und Fördertechnik.

**ConCar** Antriebs- und Förderriemen entsprechen den internationalen Normen und Spezifikationen und werden auch in einer Vielzahl von Sonderausführungen für jeden technischen Anwendungsfall gefertigt.

**ConCar** Gummi-Keilriemen sind bedingt ölbeständig, hitzebeständig (ummantelt bis 70°C, flankenoffen formgezahnt bis 95°C), elektrisch leitfähig und schwer entflammbar.

**ConCar** Gummi-Keilriemen mit "LOBA"-Kennzeichnung sind zum Einsatz im Bergbau vom Landesoberbergamt Nordrhein-Westfalen freigegeben.

**ConCar** Gummi-Keilriemen mit dem "API"-Kennzeichen sind gemäß Zertifikat Nr. 7677 des American Petroleum Institute vom 08. Februar 1979 geeignet für den Einsatz auf Ölfeldern und in der Erdölindustrie.

**ConCar** Gummi-Keilriemen "satzgleich" werden in eingeschränkten Längentoleranzen gefertigt, welche die vorgegebenen Grenzwerte aller Normen wesentlich unterschreiten.

Preiszuschlag für Sonderausführungen:

elektrisch leitfähig, Kennzeichnung 20%  
Bergbau mit "LOBA"-Kennzeichnung 20%

Weitere Spezialqualitäten und Sonderlängen auf Anfrage.

**ConCar** V-Belts are first class products of driving and conveyor technics.

**ConCar** Power Transmission und Conveyor Belts correspond to international standards and specifications.

**ConCar** Power Transmission und Conveyor Belts are be produced in many different special constructions for every application.

**ConCar** Rubber V-Belts are limited oil-resistant, heat resistant (wrapped up to 70°C, raw edge cogged up to 95°C), electrical conductive and hardly inflammable.

**ConCar** Rubber V-Belt with "LOBA"-sign are allowed for using in mining.

**ConCar** Rubber V-Belt branded with the "API"-monogram may be used in the oil drilling and processing industrie.

**ConCar** Rubber V-Belts "satzgleich" are produced within very small length tolerances, which essentially remain under the passed regulations of all standards.

Surcharge of price for special constructions:

electrical conductivity, marking 20 %  
for mining with "LOBA" marking 20%

Further special qualities and non standard lengths on request.

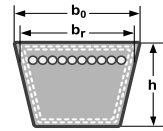

### ConCar Schmalkeilriemen nach DIN 7753 Teil 1 und BS 3790 Narrow Belts to DIN 7753 Part 1 and BS 3790

Profil Section	Abmessung Dimension $b_0 \times h$	Profilbreite unten Section base width	Wirkbreite Pitch width $b_r$	Riemenlänge / Belt length			Empfohlener Mindestscheibendurchmesser Recommended minimum pulley diameter	Riemengewicht Belt weight = kg/m	
				Nennlänge Nominal length	Außenlänge Outside length $L_a$	Wirklänge Pitch length $L_w/L_p$			Innenlänge Inside length $L_i$
SPZ	9,7 x 8	4,2	8,5	Wirklänge Pitch length $L_w/L_p$	$L_a = L_w/L_p + 13$ $L_a = L_i + 51$	—	$L_i = L_w/L_p - 38$ $L_i = L_a - 51$	63	0,070
SPA	12,7 x 10	5,8	11,0		$L_a = L_w/L_p + 18$ $L_a = L_i + 63$	—	$L_i = L_w/L_p - 45$ $L_i = L_a - 63$	90	0,119
SPB	16,3 x 13	7,3	14,0		$L_a = L_w/L_p + 22$ $L_a = L_i + 82$	—	$L_i = L_w/L_p - 60$ $L_i = L_a - 82$	140	0,194
SPC	22 x 18	9,6	19,0		$L_a = L_w/L_p + 30$ $L_a = L_i + 113$	—	$L_i = L_w/L_p - 83$ $L_i = L_a - 113$	224	0,360
19	18,6 x 15	8,3	16,0		$L_a = L_w/L_p + 25$ $L_a = L_i + 94$	—	$L_i = L_w/L_p - 69$ $L_i = L_a - 94$	180	0,250

### ConCar Schmalkeilriemen nach USA-Standard RMA/MPTA / Narrow Belts to USA-Standard RMA/MPTA

				Außenlänge Outside length $L_a$		$L_w/L_p \approx L_a - 4$	$L_i = L_a - 42$	Außendurchmesser Outside diameter $d_a$	
3V/9N	9 x 8	4,2	—	—	—	—	—	63	0,070
5V/15N	15 x 13	7,3	—	—	—	—	—	140	0,194
8V/25N	25 x 23	9,6	—	—	—	—	—	315	0,567

### ConCar REX Formgezahnte, flankenoffene Schmalkeilriemen nach DIN 7753 Teil 1 und BS 3790 Moulded cogged raw edge Narrow Belts to DIN 7753 Part 1 and BS 3790

				Wirklänge Pitch length $L_w/L_p$	$L_a = L_w/L_p + 13$ $L_a = L_i + 51$	—	$L_i = L_w/L_p - 38$ $L_i = L_a - 51$	Wirkdurchmesser Pitch diameter $d_w/d_p$		
XPZ	9,7 x 8	4,2	8,5		$L_a = L_w/L_p + 18$ $L_a = L_i + 63$	—	$L_i = L_w/L_p - 45$ $L_i = L_a - 63$		56	0,065
XPA	12,7 x 10	5,8	11,0		$L_a = L_w/L_p + 22$ $L_a = L_i + 82$	—	$L_i = L_w/L_p - 60$ $L_i = L_a - 82$		71	0,111
XPB	16,3 x 13	7,3	14,0		$L_a = L_w/L_p + 30$ $L_a = L_i + 113$	—	$L_i = L_w/L_p - 83$ $L_i = L_a - 113$		112	0,183
XPC	22 x 18	9,6	19,0			—			180	0,340

### ConCar REX Formgezahnte, flankenoffene Schmalkeilriemen nach USA-Standard RMA/MPTA Moulded cogged raw edge Narrow Belts to USA-Standard RMA/MPTA

				Außenlänge Outside length $L_a$		$L_w/L_p \approx L_a - 4$	$L_i = L_a - 42$	Außendurchmesser Outside diameter $d_a$	
3VX	9 x 8	4,2	—	—	—	—	—	56	0,065
5VX	15 x 13	7,3	—	—	—	—	—	112	0,183

### ConCar REX Formgezahnte, flankenoffene Keilriemen nach DIN 2215 und BS 1440 Moulded cogged raw edge V-Belts to DIN 2215 and BS 1440

				Innenlänge Inside length $L_i$	$L_a = L_i + 38$ $L_a = L_w/L_p + 16$	$L_w/L_p \approx L_i + 22$ $L_w/L_p \approx L_a - 16$	—	Wirkdurchmesser Pitch diameter $d_w/d_p$			
ZX/X10	10 x 6	5,9	8,5		$L_a = L_i + 50$ $L_a = L_w/L_p + 20$	$L_w/L_p \approx L_i + 30$ $L_w/L_p \approx L_a - 20$	—		—	40	0,062
AX/X13	13 x 8	7,5	11,0		$L_a = L_i + 69$ $L_a = L_w/L_p + 29$	$L_w/L_p \approx L_i + 40$ $L_w/L_p \approx L_a - 29$	—		—	63	0,099
BX/X17	17 x 11	9,4	14,0		$L_a = L_i + 88$ $L_a = L_w/L_p + 30$	$L_w/L_p \approx L_i + 58$ $L_w/L_p \approx L_a - 30$	—		—	90	0,165
CX/X22	22 x 14	12,3	19,0				—		—	140	0,276

### ConCar Keilriemen nach DIN 2215 und BS 1440 / V-Belts to DIN 2215 and BS 1440

				Innenlänge Inside length $L_i$	$L_a = L_i + 19$ $L_a = L_w/L_p + 8$	$L_w/L_p \approx L_i + 11$ $L_w/L_p \approx L_a - 8$	—	Wirkdurchmesser Pitch diameter $d_w/d_p$			
5	5 x 3	2,8	4,2		$L_a = L_i + 25$ $L_a = L_w/L_p + 10$	$L_w/L_p \approx L_i + 15$ $L_w/L_p \approx L_a - 10$	—		—	20	0,018
Y/6	6 x 4	3,3	5,3		$L_a = L_i + 31$ $L_a = L_w/L_p + 12$	$L_w/L_p \approx L_i + 19$ $L_w/L_p \approx L_a - 12$	—		—	28	0,026
8	8 x 5	4,5	6,7		$L_a = L_i + 38$ $L_a = L_w/L_p + 16$	$L_w/L_p \approx L_i + 22$ $L_w/L_p \approx L_a - 16$	—		—	40	0,042
Z/10	10 x 6	5,9	8,5		$L_a = L_i + 50$ $L_a = L_w/L_p + 20$	$L_w/L_p \approx L_i + 30$ $L_w/L_p \approx L_a - 20$	—		—	50	0,065
A/13	13 x 8	7,5	11,0		$L_a = L_i + 69$ $L_a = L_w/L_p + 29$	$L_w/L_p \approx L_i + 40$ $L_w/L_p \approx L_a - 29$	—		—	71	0,112
B/17	17 x 11	9,4	14,0		$L_a = L_i + 79$ $L_a = L_w/L_p + 31$	$L_w/L_p \approx L_i + 48$ $L_w/L_p \approx L_a - 31$	—		—	122	0,198
20	20 x 12,5	11,4	17,0		$L_a = L_i + 88$ $L_a = L_w/L_p + 30$	$L_w/L_p \approx L_i + 58$ $L_w/L_p \approx L_a - 30$	—		—	160	0,268
C/22	22 x 14	12,3	19,0		$L_a = L_i + 100$ $L_a = L_w/L_p + 39$	$L_w/L_p \approx L_i + 61$ $L_w/L_p \approx L_a - 39$	—		—	180	0,330
25	25 x 16	14,0	21,0		$L_a = L_i + 126$ $L_a = L_w/L_p + 51$	$L_w/L_p \approx L_i + 75$ $L_w/L_p \approx L_a - 51$	—		—	250	0,422
D/32	32 x 20	18,2	27,0		$L_a = L_i + 157$ $L_a = L_w/L_p + 77$	$L_w/L_p \approx L_i + 80$ $L_w/L_p \approx L_a - 77$	—		—	355	0,675
E/40	40 x 25	22,8	32,0				—		—	500	1,030

### ConCar Kfz-Keilriemen nach DIN 7753 Blatt 3, BS AU 150 und ISO 2790 Fan-Belts to DIN 7753 Part 3, BS AU 150 and ISO 2790

				Außenlänge Outside length $L_a$		$L_w/L_p \approx L_a - 13$	$L_i = L_a - 51$	
AV10/9,5	10 x 8	4,9	8,5	—	—	—	—	0,070
AV13/12,5	13 x 10	5,8	11,0	—	—	—	—	0,119

### ConCar REX Kfz-Keilriemen nach DIN 7753 Blatt 3, BS AU 150 und ISO 2790 Moulded cogged raw edge Fan-Belts to DIN 7753 Part 3, BS AU 150 and ISO 2790

				Außenlänge Outside length $L_a$		$L_w/L_p \approx L_a - 13$	$L_i = L_a - 48$	
AVX10/9,5	10 x 8	4,9	8,5	—	—	—	—	0,065
AVX13/12,5	13 x 10	5,8	11,0	—	—	—	—	0,111

## Technische Daten, Meßgeräte

## Technical Data, Measuring Instruments

Kraftband-Profile, Hochleistungs-Schmalkeilriemen  
Banded-Belt Sections, High Capacity Narrow V-Belt

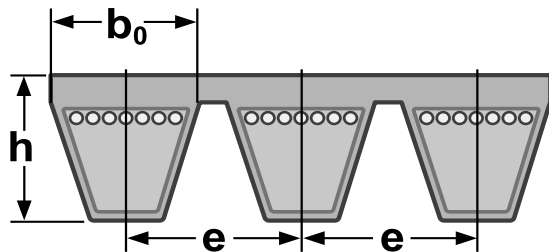

Profil/ Section	3V/9J	5V/15J	8V/25J	SPB	SPC
$b_0 \approx$	9	15	25	16,5	22
$h \approx$	9,9	15,1	25,5	15,6	22,6
$e \approx$	10,3	17,5	28,6	19	25,5

Kraftband-Profile, Klassische Keilriemen  
Banded-Belt Sections, Classical V-Belt

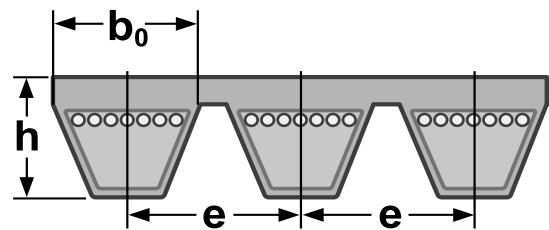

Profil/ Section	A/HA	B/HB	C/HC	C/HC
$b_0 \approx$	13	17	22	32
$h \approx$	9,9	13	16,2	22,4
$L_a \approx L_i +$	36	62	75	111
$e \approx$	15,88	19,05	25,4	36,53

Doppelkeilriemen-Profile  
Double V-Belt Sections

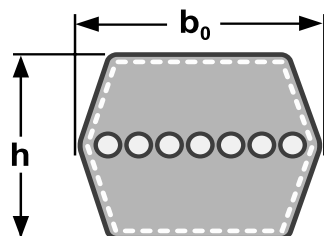

Profil/ Section	AA/HAA	BB/HBB	CC/HCC
$b_0 \approx$	13	17	22
$h \approx$	10	13	17

Meßlatte für Keilriemen bis 2000 mm  
Measuring gauge for V-Belts up to 2000 mm

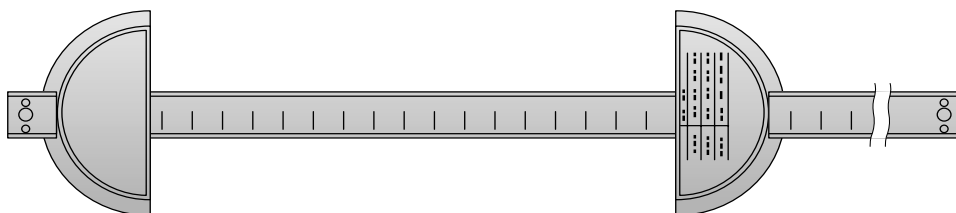

Spannkrafttester  
Tension gauge



Preise auf Anfrage.  
Prices on request.



SPZ			AV 10/9,5			SPA			AV 13/12,5		
LW/LD= Richtlänge pitch length mm	LA= Außenlänge outside length mm	Stück piece Euro	LW/LD= Richtlänge pitch length mm	LA= Außenlänge outside length mm	Stück piece Euro	LW/LD= Richtlänge pitch length mm	LA= Außenlänge outside length mm	Stück piece Euro	LW/LD= Richtlänge pitch length mm	LA= Außenlänge outside length mm	Stück piece Euro
487	500	6,60	1462	1475	12,30	732	750	9,20			
512	525	6,60	1487	1500	12,30	757	775	9,20			
562	575	6,60	1500	1513	12,30	782	800	9,20			
587	600	6,60	1512	1525	13,50	800	818	9,20			
612	625	6,60	1537	1550	13,50	807	825	9,90			
630	643	7,10	1562	1575	13,50	832	850	9,90			
637	650	7,10	1587	1600	13,50	850	868	9,90			
662	675	7,10	1600	1613	13,50	857	875	9,90			
670	685	7,10	1612	1625	14,40	882	900	9,90			
687	700	7,10	1637	1650	14,40	900	918	9,90			
710	725	7,10	1662	1675	14,40	907	925	11,40			
722	735	7,10	1687	1700	14,40	932	950	11,40			
737	750	7,10	1700	1713	14,40	950	968	11,40			
750	763	7,10	1712	1725	14,90	957	975	11,40			
762	775	7,10	1737	1750	14,90	982	1000	11,40			
772	785	7,10	1762	1775	14,90	1000	1018	11,40			
787	800	7,10	1787	1800	14,90	1007	1025	13,20			
800	813	7,10	1800	1813	14,90	1032	1050	13,20			
812	825	7,50	1812	1825	15,50	1042	1060	13,20			
825	838	7,50	1837	1850	15,50	1060	1075	13,20			
837	850	7,50	1862	1875	15,50	1082	1100	13,20			
850	864	7,50	1887	1900	15,50	1107	1125	13,20			
862	875	7,50	1900	1913	15,50	1120	1138	13,20			
875	888	7,50	1912	1925	16,30	1132	1150	14,30			
887	900	7,50	1937	1950	16,30	1157	1175	14,30			
900	913	7,50	1962	1975	16,30	1180	1200	14,30			
912	925	7,80	1987	2000	16,30	1207	1225	14,30			
925	940	7,80	2000	2013	16,30	1232	1250	14,30			
937	950	7,80	2037	2050	17,20	1250	1268	14,30			
950	965	7,80	2062	2075	17,20	1257	1275	15,40			
962	975	7,80	2087	2100	17,20	1272	1290	15,40			
987	1000	7,80	2120	2133	17,20	1282	1300	15,40			
1000	1016	7,80	2137	2150	17,20	1307	1325	15,40			
1012	1025	9,20	2187	2200	17,20	1320	1338	15,40			
1024	1037	9,20	2207	2220	18,60	1332	1350	16,10			
1037	1050	9,20	2240	2253	18,60	1357	1375	16,10			
1047	1060	9,20	2287	2300	19,30	1382	1400	16,10			
1060	1075	9,20	2360	2373	19,30	1400	1418	16,10			
1077	1090	9,20	2500	2513	20,90	1407	1425	17,50			
1087	1100	9,20	2650	2663	21,80	1432	1450	17,50			
1112	1125	9,20	2800	2813	23,30	1457	1475	17,50			
1120	1133	9,20	3000	3013	24,00	1482	1500	17,50			
1137	1150	9,80	3150	3163	25,60	1500	1518	17,50			
1150	1163	9,80	3350	3363	27,90	1507	1525	18,00			
1162	1175	9,80	3550	3563	28,60	1532	1550	18,00			
1180	1193	9,80				1557	1575	18,00			
1187	1200	9,80				1582	1600	18,00			
1202	1215	9,80				1600	1618	18,00			
1212	1225	9,80				1607	1625	19,50			
1227	1240	9,80				1632	1650	19,50			
1237	1250	9,80				1657	1675	19,50			
1250	1263	9,80				1682	1700	19,50			
1262	1275	11,20				1700	1718	19,50			
1287	1300	11,20				1707	1725	20,30			
1312	1325	11,20				1732	1750	20,30			
1320	1333	11,20				1757	1775	20,30			
1329	1342	12,00				1782	1800	20,30			
1337	1350	12,00				1800	1818	20,30			
1362	1375	12,00				1807	1825	21,80			
1387	1400	12,00				1832	1850	21,80			
1400	1413	12,00				1857	1875	21,80			
1412	1425	12,30				1882	1900	21,80			
1437	1450	12,30				1900	1918	21,80			

Gewicht/ weight = 0,070 kg/m

Gewicht/ weight = 0,119 kg/m



SPA			Profil/Section SPB		Profil/Section SPC	
LW/LD= Richtlänge pitch length mm	AV 13/12,5 LA= Außenlänge outside length mm	Stück piece  Euro	LW/LD= Richtlänge pitch length mm	Stück piece  Euro	LW/LD= Richtlänge pitch length mm	Stück piece  Euro
1907	1925	22,70	1250	20,80	2000	52,60
1932	1950	22,70	1320	21,20	2120	54,90
1957	1975	22,70	1350	21,40	2240	58,50
1982	2000	22,70	1400	21,80	2360	62,10
2000	2018	22,70	1450	22,60	2500	64,30
2032	2050	23,70	1500	24,30	2650	68,60
2057	2075	23,70	1550	25,10	2800	73,50
2082	2100	23,70	1600	26,20	3000	78,30
2120	2138	23,70	1650	27,00	3150	79,40
2132	2150	24,50	1700	27,60	3250	80,90
2182	2200	24,50	1750	28,40	3350	82,40
2207	2225	24,50	1800	29,20	3550	87,20
2232	2250	24,50	1850	30,20	3620	89,70
2240	2258	24,50	1900	31,10	3750	92,40
2282	2300	26,10	1950	31,90	4000	99,70
2300	2318	26,10	2000	33,10	4250	104,50
2307	2325	26,10	2020	33,30	4400	108,10
2332	2350	26,10	2060	34,00	4500	109,80
2360	2378	26,10	2120	34,90	4750	118,70
2382	2400	26,10	2150	35,80	5000	125,40
2432	2450	27,40	2180	36,10	5300	132,50
2482	2500	27,40	2240	37,10	5600	148,00
2500	2518	27,40	2285	37,70	6000	155,90
2532	2550	29,50	2360	38,90	6300	166,70
2557	2575	29,50	2391	39,80	6700	175,50
2582	2600	29,50	2410	41,50	7100	191,00
2607	2625	29,50	2430	41,50	7500	198,80
2632	2650	29,50	2500	41,50	8000	202,00
2650	2668	29,50	2530	42,00	8500	223,90
2682	2700	31,10	2550	42,30	9000	240,00
2732	2750	31,10	2650	43,10	9500	255,60
2782	2800	31,10	2680	44,00	10000	264,50
2800	2818	31,10	2730	44,80	10600	280,50
2832	2850	33,10	2800	45,90	11200	299,40
2865	2883	33,10	2850	46,90	11800	316,40
2882	2900	33,10	2900	47,60	12500	328,50
2900	2918	33,10	3000	49,30		
2932	2950	33,10	3070	50,50		
2982	3000	33,10	3150	50,50		
3000	3018	33,10	3170	50,80		
3032	3050	34,90	3250	51,70		
3082	3100	34,90	3350	52,30		
3150	3168	34,90	3450	53,90		
3182	3200	36,80	3485	54,40		
3250	3268	36,80	3550	57,60		
3282	3300	36,80	3650	59,30		
3350	3368	36,80	3750	60,90		
3382	3400	40,10	3870	62,20		
3450	3468	40,10	4000	64,30		
3482	3500	40,10	4060	65,50		
3550	3568	40,10	4250	68,60		
3632	3650	42,60	4500	73,50		
3650	3668	42,60	4750	77,60		
3750	3768	42,60	4870	79,00		
4000	4018	44,80	5000	81,10		
4250	4268	46,10	5300	86,60		
4500	4518	49,30	5600	92,00		
			6000	97,40		
			6300	102,00		
			6700	109,20		
			7100	117,50		
			7500	121,20		
			8000	128,30		
Gewicht/ weight = 0,119 kg/m			Gewicht/ weight = 0,194 kg/m		Gewicht/ weight = 0,360 kg/m	



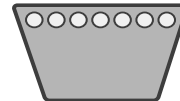

Profil/Section 8 x 5 mm				Profil/Section 10 X 6 mm Z			
Code - Nr.	Richtlänge pitch length ISO / LD mm	Innenlänge inside length mm	Stück piece Euro	Code - Nr.	Richtlänge pitch length ISO / LD mm	Innenlänge inside length mm	Stück piece Euro
	335	315	7,50	Z 13	362	340	7,50
	<b>375</b>	<b>355</b>	7,50	Z 14	372	355	7,50
	<b>395</b>	<b>375</b>	7,50	Z 14 ¾	397	375	7,50
	<b>405</b>	<b>385</b>	7,50	Z 15 1/2	422	400	7,50
	<b>420</b>	<b>400</b>	7,50	Z 16 1/2	447	425	7,50
	<b>445</b>	<b>425</b>	7,50	Z 17 1/2	472	450	7,50
	<b>470</b>	<b>450</b>	7,50	Z 18 1/2	497	475	7,50
	<b>495</b>	<b>475</b>	7,50	Z 19	502	480	7,50
	<b>520</b>	<b>500</b>	7,50	Z 19 1/2	522	500	7,50
	<b>550</b>	<b>530</b>	7,50	Z 20	530	508	7,50
	<b>565</b>	<b>545</b>	7,50	Z 20 1/3	537	515	7,50
	<b>570</b>	<b>550</b>	7,50	Z 20 ¾	547	525	7,50
	<b>580</b>	<b>560</b>	7,50	Z 21	552	530	7,50
	<b>595</b>	<b>575</b>	7,50	Z 21 1/2	562	540	7,50
	<b>600</b>	<b>580</b>	7,50	Z 22	582	560	7,50
	<b>620</b>	<b>600</b>	7,50	Z 22 1/2	597	575	7,70
	<b>650</b>	<b>630</b>	7,50	Z 23 1/2	622	600	7,70
	<b>670</b>	<b>650</b>	7,50	Z 24	632	610	7,70
	<b>690</b>	<b>670</b>	7,50	Z 25	652	630	7,70
	<b>720</b>	<b>700</b>	7,50	Z 25 1/2	672	650	7,70
	<b>730</b>	<b>710</b>	7,50	Z 26 1/2	692	670	7,70
	<b>745</b>	<b>725</b>	7,50	Z 27 1/2	722	700	7,70
	<b>770</b>	<b>750</b>	7,50	Z 28	732	710	7,70
	<b>780</b>	<b>760</b>	7,50	Z 28 1/2	747	725	7,70
	<b>795</b>	<b>775</b>	7,50	Z 29	752	730	7,70
	<b>820</b>	<b>800</b>	7,50	Z 29 1/2	772	750	7,70
	845	825	8,30	Z 30	787	765	7,70
	850	830	8,30	Z 30 1/2	797	775	7,70
	870	850	8,30	Z 31 1/2	822	800	8,00
	895	875	8,30	Z 32	842	820	8,00
	920	900	8,30	Z 32 1/2	847	825	8,00
	970	950	8,30	Z 33 1/2	872	850	8,00
	985	965	8,30	Z 34	887	865	8,00
	1020	1000	8,30	Z 34 1/2	897	875	8,00
	1040	1020	8,30	Z 35 1/2	922	900	8,00
	1070	1050	8,30	Z 36 1/2	947	925	8,00
	1095	1075	8,30	Z 37 1/2	972	950	8,00
	1140	1120	8,30	Z 38 1/2	997	975	8,00
	1220	1200	9,40	Z 38 ¾	1002	980	8,00
	1270	1250	9,40	Z 39 1/2	1022	1000	8,40
				Z 40	1038	1016	8,40
				Z 40 1/2	1052	1030	8,40
				Z 41	1063	1041	8,40
				Z 41 1/2	1072	1050	8,40
				Z 42	1082	1060	8,40
Abmessungen in Fettdruck flankenoffen formgezahnt.				Z 42 1/2	1102	1080	8,40
Bold-faced dimensions raw edge, moulded cogged.				Z 43 1/2	1122	1100	8,40
				Z 44	1142	1120	8,40
				Z 44 1/2	1154	1132	8,40
				Z 45	1172	1150	8,40
Profil 5 und 6 auf Anfrage.				Z 46	1187	1165	8,40
Section 5 and 6 on request.				Z 46 1/2	1202	1180	8,40
				Z 47	1216	1194	9,00
				Z 48	1237	1215	9,00
				Z 48 1/2	1247	1225	9,00
				Z 48 ¾	1257	1235	9,00
				Z 49	1272	1250	9,00
				Z 49,5	1284	1262	9,00
				Z 50	1292	1270	9,00
				Z 51	1317	1295	9,00
				Z 52	1342	1320	9,00
				Z 53	1368	1346	9,00
				Z 53 1/2	1387	1365	9,00
Gewicht/ weight = 0,042 kg/m				Gewicht / weight = 0,065 kg/m			

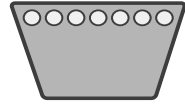

Profil / Section 10 x 6 mm Z				Profil / Section 13 x 8 mm A			
Code - Nr.	Richtlänge pitch length ISO / LD mm	Innenlänge inside length mm	Stück piece Euro	Code - Nr.	Richtlänge pitch length ISO / LD mm	Innenlänge inside length mm	Stück piece Euro
Z 54	1393	1371	9,00	A 16	437	407	8,30
Z 55	1422	1400	9,00	A 18	487	457	8,30
Z 56	1444	1422	10,90	A 19	510	480	8,30
Z 56 1/2	1457	1435	10,90	A 20	538	508	8,30
Z 57	1472	1450	10,90	A 21	565	535	8,30
Z 58	1497	1475	10,90	A 22	590	560	8,30
Z 59	1522	1500	10,90	A 22 1/2	605	575	8,30
Z 60	1546	1524	11,50	A 23	615	585	8,30
Z 61	1572	1550	11,50	A 23 1/2	630	600	8,30
Z 62	1597	1575	11,50	A 24	640	610	8,30
Z 63	1622	1600	11,50	A 24 1/2	660	630	8,30
Z 64	1648	1626	12,40	A 25	665	635	8,30
Z 65	1673	1651	12,40	A 25 1/2	680	650	8,30
Z 66	1697	1675	12,40	A 26	690	660	8,30
Z 67	1722	1700	12,40	A 26 1/2	700	670	8,30
Z 68	1747	1725	13,20	A 27	716	686	8,30
Z 69	1772	1750	13,20	A 27 1/2	730	700	8,30
Z 70	1797	1775	13,20	A 28	740	710	8,30
Z 71	1822	1800	13,20	A 29	760	730	8,30
Z 73	1872	1850	14,60	A 29 1/2	780	750	8,30
Z 75	1922	1900	14,60	A 30	797	767	8,30
Z 78	1997	1975	14,60	A 30 1/2	805	775	8,30
Z 79	2022	2000	14,90	A 31	817	787	8,30
Z 83 1/2	2142	2120	14,90	A 31 1/2	830	800	8,30
Z 88	2262	2240	16,50	A 32	843	813	8,50
Z 93	2382	2360	16,50	A 32 1/2	855	825	8,50
Z 98 1/2	2522	2500	16,50	A 33	871	841	8,50
				A 33 1/2	880	850	8,50
				A 34	893	863	8,50
				A 34 1/2	905	875	8,50
				A 35	919	889	8,50
				A 35 1/2	930	900	8,50
				A 36	944	914	9,50
				A 36 1/2	955	925	9,50
				A 37	970	940	9,50
				A 37 1/2	980	950	9,50
				A 38	995	965	9,50
				A 38 1/2	1005	975	9,50
				A 39	1020	990	9,50
				A 39 1/2	1030	1000	9,50
				A 40	1040	1016	9,50
				A 40 1/2	1060	1030	9,50
				A 41	1071	1041	9,50
				A 41 1/2	1080	1050	9,50
				A 42	1090	1060	9,50
				A 42 1/2	1105	1075	10,30
				A 43	1120	1090	10,30
				A 43 ¼	1130	1100	10,30
				A 43 1/2	1135	1105	10,30
				A 44	1150	1120	10,30
				A 45	1173	1143	10,30
				A 45 1/2	1180	1150	10,30
				A 46	1198	1168	10,30
				A 46 1/2	1210	1180	10,30
				A 47	1220	1190	11,20
				A 47 1/2	1230	1200	11,20
				A 48	1245	1215	11,20
				A 48	1250	1220	11,20
				A 48 1/2	1255	1225	11,20
				A 48 ¾	1270	1240	11,20
				A 49	1280	1250	11,20
				A 50	1300	1270	12,20
				A 51	1330	1300	12,20
Gewicht/ weight = 0,065 kg/m				Gewicht/ weight = 0,112 kg/m			

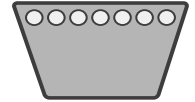

Profil / Section 13 x 8 mm A				Profil / Section 13 x 8 mm A			
Code - Nr.	Richtlänge pitch length ISO / LD mm	Innenlänge inside length mm	Stück piece Euro	Code - Nr.	Richtlänge pitch length ISO / LD mm	Innenlänge inside length mm	Stück piece Euro
A 52	1350	1320	12,20	A 148	3780	3750	31,20
A 53	1380	1350	12,20	A 157 1/2	4030	4000	31,90
A 54	1405	1375	12,20	A 167	4280	4250	34,40
A 55	1430	1400	12,20	A 187	4780	4750	39,10
A 56	1452	1422	13,50	A 197	5030	5000	40,60
A 57	1480	1450	13,50				
A 58	1505	1475	13,50				
A 59	1530	1500	13,50				
A 60	1555	1525	13,50				
A 61	1580	1550	13,50				
A 62	1605	1575	13,50				
A 63	1630	1600	13,50				
A 64	1655	1625	14,60				
A 65	1680	1650	14,60				
A 66	1706	1676	14,60				
A 67	1730	1700	14,60				
A 68	1755	1725	14,60				
A 69	1780	1750	14,60				
A 70	1805	1775	14,60				
A 71	1830	1800	14,60				
A 72	1855	1825	16,00				
A 73	1884	1854	16,00				
A 74	1910	1880	16,00				
A 75	1930	1900	16,00				
A 76	1960	1930	16,00				
A 77	1986	1956	16,00				
A 78	2010	1980	16,00				
A 79	2030	2000	16,00				
A 80	2062	2032	17,00				
A 81	2090	2060	17,00				
A 82	2113	2083	17,00				
A 83	2130	2100	17,00				
A 83 1/2	2150	2120	17,00				
A 84	2164	2134	18,00				
A 84 1/2	2180	2150	18,00				
A 85	2190	2160	18,00				
A 86	2215	2185	18,00				
A 86 1/2	2230	2200	18,00				
A 87	2240	2210	18,00				
A 87 1/2	2250	2220	18,00				
A 88	2270	2240	18,00				
A 89	2290	2260	19,00				
A 90	2316	2286	19,00				
A 93	2390	2360	19,00				
A 96	2468	2438	19,00				
A 97	2494	2464	19,00				
A 98 1/2	2530	2500	19,00				
A 100	2570	2540	21,80				
A 102	2621	2591	21,80				
A 104	2680	2650	21,80				
A 105	2697	2667	21,80				
A 107	2755	2725	21,80				
A 108	2773	2743	21,80				
A 110	2830	2800	21,80				
A 112	2875	2845	25,00				
A 118	3030	3000	25,00				
A 120	3078	3048	25,00				
A 124	3180	3150	25,00				
A 128	3280	3250	27,60				
A 132	3380	3350	27,60				
A 136	3484	3454	27,60				
A 140	3580	3550	27,60				
A 144	3688	3658	31,20				

Gewicht/ weight = 0,112 kg/m

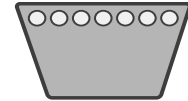

Profil / Section 17 x 11 mm B				Profil / Section 17 x 11 mm B			
Code - Nr.	Richtlänge pitch length ISO / LD mm	Innenlänge inside length mm	Stück piece Euro	Code - Nr.	Richtlänge pitch length ISO / LD mm	Innenlänge inside length mm	Stück piece Euro
B 22 1/2	610	570	10,10	B 64	1665	1625	21,90
B 24	655	615	10,10	B 65	1690	1650	21,90
B 25	670	630	10,10	B 66	1716	1676	21,90
B 25 1/2	690	650	10,10	B 67	1740	1700	21,90
B 26 1/2	710	670	10,10	B 68	1765	1725	22,30
B 27	726	686	10,10	B 69	1790	1750	22,30
B 28	750	710	10,10	B 69 1/2	1801	1761	22,30
B 28 1/2	765	725	10,10	B 70	1815	1775	22,30
B 29 1/2	790	750	10,10	B 71	1840	1800	22,30
B 30	802	762	10,10	B 72	1869	1829	23,50
B 30 1/2	815	775	10,10	B 73	1890	1850	23,50
B 31	827	787	10,10	B 74	1920	1880	23,50
B 31 1/2	840	800	10,10	B 75	1940	1900	23,50
B 32	853	813	11,50	B 76	1970	1930	23,50
B 32 1/2	865	825	11,50	B 77	1990	1950	23,50
B 33	876	836	11,50	B 78	2021	1981	23,50
B 33 1/2	890	850	11,50	B 79	2040	2000	23,50
B 34	904	864	11,50	B 80	2072	2032	25,20
B 34 1/2	915	875	11,50	B 81	2100	2060	25,20
B 35	929	889	11,50	B 82	2123	2083	25,20
B 35 1/2	940	900	11,50	B 83	2140	2100	25,20
B 36	954	914	12,40	B 83 1/2	2160	2120	25,20
B 36 1/2	965	925	12,40	B 84	2170	2130	27,60
B 37	980	940	12,40	B 85	2200	2160	27,60
B 37 1/2	990	950	12,40	B 86	2225	2185	27,60
B 38	1005	965	12,40	B 86 1/2	2240	2200	27,60
B 38 1/2	1015	975	12,40	B 87	2550	2210	27,60
B 39	1030	990	12,40	B 88	2280	2240	27,60
B 39 1/2	1040	1000	12,40	B 89	2300	2260	28,60
B 40	1056	1016	12,40	B 90	2326	2286	28,60
B 40 1/2	1070	1030	13,20	B 90 1/2	2340	2300	28,60
B 41	1080	1040	13,20	B 91	2350	2310	28,60
B 41 1/2	1090	1050	13,20	B 92	2370	2330	28,60
B 42	1100	1060	13,20	B 93	2400	2360	28,60
B 42 1/2	1115	1075	13,20	B 94	2420	2380	30,40
B 43	1130	1090	13,20	B 94 1/2	2440	2400	30,40
B 43 1/2	1140	1100	13,20	B 95	2453	2413	30,40
B 44	1160	1120	13,20	B 96	2478	2438	30,40
B 45	1190	1150	15,30	B 96 1/2	2490	2450	30,40
B 45 1/2	1203	1163	15,30	B 97	2505	2465	30,40
B 46	1215	1175	15,30	B 98	2530	2490	30,40
B 46 1/2	1220	1180	15,30	B 98 1/2	2540	2500	30,40
B 47	1230	1190	15,30	B 99	2560	2520	30,40
B 47 1/2	1240	1200	15,70	B 100	2580	2540	30,40
B 48	1255	1215	15,70	B 101	2610	2570	32,10
B 48 1/2	1265	1225	15,70	B 102	2640	2600	32,10
B 49	1290	1250	15,70	B 103	2665	2625	32,10
B 50	1315	1275	16,50	B 104	2690	2650	32,10
B 51	1340	1300	16,50	B 105	2707	2667	32,80
B 52	1360	1320	16,50	B 106	2740	2700	32,80
B 52 1/2	1375	1335	17,50	B 108	2790	2750	32,80
B 53	1390	1350	17,50	B 110	2840	2800	32,80
B 53 1/2	1400	1360	17,50	B 112	2885	2845	32,80
B 54	1412	1372	17,50	B 114	2940	2900	36,50
B 55	1440	1400	17,50	B 116	2990	2950	36,50
B 56	1462	1422	19,10	B 118	3040	3000	36,50
B 57	1490	1450	19,10	B 120	3088	3048	39,10
B 58	1513	1473	19,10	B 122	3140	3100	39,10
B 59	1540	1500	19,10	B 124	3190	3150	39,10
B 60	1565	1525	19,60	B 126	3240	3200	40,60
B 61	1590	1550	19,60	B 128	3290	3250	40,60
B 62	1615	1575	19,60	B 130	3340	3300	40,60
B 63	1640	1600	19,60	B 132	3390	3350	40,60

Gewicht/ weight = 0,198 kg/m

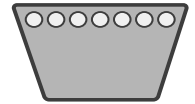

Profil / Section 17 x 11 mm B				Profil / Section 20 x 12,5 mm			
Code - Nr.	Richtlänge pitch length ISO / LD mm	Innenlänge inside length mm	Stück piece Euro	Code - Nr.	Richtlänge pitch length ISO / LD mm	Innenlänge inside length mm	Stück piece Euro
B 134	3440	3400	43,60		950	900	14,90
B 135	3470	3430	43,60		1000	950	14,90
B 136	3490	3450	43,60		1025	975	14,90
B 138	3540	3500	43,60		1050	1000	14,90
B 140	3590	3550	43,60		1080	1030	17,10
B 142	3640	3600	43,60		1110	1060	17,10
B 144	3698	3658	45,50		1170	1120	17,10
B 146	3740	3700	45,50		1200	1150	19,60
B 148	3790	3750	45,50		1230	1180	19,60
B 151 1/2	3890	3850	49,20		1250	1200	19,60
B 155 1/2	3990	3950	49,20		1265	1215	19,60
B 157 1/2	4040	4000	49,20		1300	1250	19,60
B 162	4155	4115	52,00		1325	1275	20,80
B 165	4240	4200	52,00		1350	1300	20,80
B 167	4290	4250	52,00		1370	1320	20,80
B 173	4435	4395	54,40		1400	1350	21,90
B 175	4490	4450	54,40		1450	1400	21,90
B 177	4540	4500	54,40		1500	1450	21,90
B 180	4612	4572	54,40		1550	1500	21,90
B 187	4790	4750	54,40		1650	1600	23,70
B 195	4993	4953	62,10		1700	1650	25,40
B 197	5040	5000	62,10		1750	1700	25,40
B 208 1/2	5340	5300	66,20		1800	1750	28,40
B 210	5374	5334	69,80		1825	1775	28,40
B 220 1/2	5640	5600	70,50		1850	1800	28,40
B 236	6040	6000	75,20		1925	1875	29,40
B 248	6340	6300	79,40		1950	1900	29,40
B 256	6590	6500	83,00		1975	1925	29,40
B 264	6740	6700	84,70		2000	1950	29,40
B 276	7040	7000	89,00		2050	2000	29,60
B 279 1/2	7140	7100	90,20		2100	2050	34,80
					2170	2120	34,80
					2250	2200	35,30
					2290	2240	35,30
					2410	2360	37,40
					2550	2500	37,80
					2650	2600	40,20
					2700	2650	40,20
					2850	2800	42,00
					2950	2900	44,70
					3050	3000	44,70
					3200	3150	48,30
					3300	3250	49,90
					3400	3350	49,90
					3500	3450	52,40
					3600	3550	52,40
					3700	3650	55,70
					3800	3750	55,70
					4050	4000	58,40
					4300	4250	63,20
					4550	4500	67,40
					4800	4750	70,90
					5050	5000	74,00
					5350	5300	81,90
					5650	5600	83,00
					6050	6000	89,00
					6350	6300	94,30
					6750	6700	100,30
					7150	7100	105,70
					7550	7500	114,50
					8050	8000	124,00
Gewicht/ weight = 0,198 kg/m				Gewicht/ weight = 0,268 kg/m			

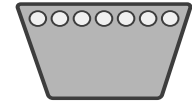

Profil / Section 22 x 14 mm C				Profil / Section 22 x 14 mm C			
Code - Nr.	Richtlänge pitch length ISO / LD mm	Innenlänge inside length mm	Stück piece Euro	Code - Nr.	Richtlänge pitch length ISO / LD mm	Innenlänge inside length mm	Stück piece Euro
C 39 1/2	1058	1000	19,50	C 140	3608	3550	59,30
C 43	1148	1090	19,50	C 142	3658	3600	62,20
C 46 1/2	1238	1180	20,30	C 144	3716	3658	63,20
C 47	1258	1200	20,30	C 146	3758	3700	63,20
C 47 1/2	1273	1215	20,30	C 148	3808	3750	63,20
C 48	1278	1220	20,30	C 150	3868	3810	67,40
C 49	1308	1250	20,30	C 152	3918	3860	67,40
C 51	1353	1295	22,20	C 157 1/2	4058	4000	67,40
C 52	1378	1320	22,20	C 161 1/2	4158	4100	67,40
C 53	1408	1350	23,40	C 167	4308	4250	73,50
C 54	1433	1375	23,40	C 173	4452	4394	73,50
C 55	1458	1400	23,40	C 177	4558	4500	76,90
C 56	1483	1425	25,60	C 180	4633	4575	80,10
C 57	1508	1450	25,60	C 187	4808	4750	80,10
C 59	1558	1500	25,60	C 195	5011	4953	84,30
C 60	1582	1524	27,00	C 197	5058	5000	84,70
C 61	1608	1550	27,00	C 204	5240	5182	91,60
C 62	1632	1574	27,00	C 208	5358	5300	93,70
C 63	1658	1600	27,00	C 210	5392	5334	94,80
C 65	1708	1650	29,00	C 220	5658	5600	104,60
C 66	1733	1675	29,00	C 225	5773	5715	109,20
C 67	1758	1700	29,00	C 236	6058	6000	117,50
C 68	1785	1727	30,20	C 240	6154	6096	118,60
C 69	1808	1750	30,20	C 248	6358	6300	120,70
C 70	1836	1778	30,20	C 264	6758	6700	128,20
C 71	1858	1800	30,20	C 270	6916	6858	131,20
C 72	1883	1825	33,40	C 279	7158	7100	145,70
C 73	1908	1850	33,40	C 295	7558	7500	159,50
C 74	1933	1875	33,40	C 315	8058	8000	171,30
C 75	1958	1900	33,40				
C 78	2008	1950	33,70				
C 79	2058	2000	34,00				
C 80	2083	2025	34,00				
C 81	2118	2060	35,20				
C 83	2158	2100	35,70				
C 83 1/2	2178	2120	36,60				
C 85	2217	2159	36,60				
C 87	2268	2210	37,30				
C 87 1/2	2278	2220	37,30				
C 88	2298	2240	37,30				
C 90	2344	2286	40,10				
C 93	2418	2360	40,10				
C 95	2478	2420	42,20				
C 96	2496	2438	42,20				
C 96 1/2	2508	2450	42,20				
C 98 1/2	2558	2500	42,20				
C 99 1/2	2583	2525	43,80				
C 100	2598	2540	43,80				
C 101	2618	2560	43,80				
C 102	2658	2600	43,80				
C 104	2708	2650	45,00				
C 105	2725	2667	45,00				
C 108	2808	2750	45,00				
C 110	2858	2800	45,00				
C 112	2903	2845	49,90				
C 116	3008	2950	49,90				
C 117	3023	2965	49,90				
C 118	3058	3000	49,90				
C 120	3106	3048	52,10				
C 124	3208	3150	52,70				
C 128	3308	3250	55,90				
C 132	3408	3350	56,30				
C 136	3508	3450	59,30				

Gewicht/ weight = 0,330 kg/m

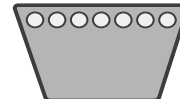

Profil / Section 25 x 16 mm				Profil / Section 32 x 20 mm D			
Code - Nr.	Richtlänge pitch length ISO / LD mm	Innenlänge inside length mm	Stück piece Euro	Code - Nr.	Richtlänge pitch length ISO / LD mm	Innenlänge inside length mm	Stück piece Euro
	1410	1350	28,30	D 79	2075	2000	78,50
	1460	1400	28,30	D 98 1/2	2575	2500	78,50
	1560	1500	31,20	D 104	2725	2650	84,50
	1660	1600	32,90	D 110	2875	2800	88,80
	1760	1700	34,60	D 118	3075	3000	95,10
	1860	1800	36,10	D 120	3123	3048	96,20
	1910	1850	38,00	D 124	3225	3150	97,20
	1960	1900	38,00	D 128	3326	3251	101,00
	2020	1950	39,10	D 132	3425	3350	104,70
	2060	2000	39,40	D 135	3500	3425	106,20
	2110	2050	41,60	D 140	3625	3550	108,40
	2180	2120	41,60	D 144	3733	3658	111,20
	2260	2200	43,80	D 148	3825	3750	112,20
	2300	2240	43,80	D 154 1/2	4000	3925	122,90
	2385	2325	44,30	D 157 1/2	4075	4000	122,90
	2420	2360	44,30	D 167	4325	4250	130,40
	2510	2450	48,40	D 173	4469	4394	136,70
	2560	2500	48,40	D 177	4575	4500	138,40
	2710	2650	52,10	D 180	4647	4572	140,60
	2760	2700	52,10	D 187	4825	4750	147,00
	2860	2800	52,10	D 195	5028	4953	153,40
	3010	2950	58,60	D 197	5075	5000	154,90
	3060	3000	58,60	D 208 1/2	5375	5300	163,10
	3210	3150	61,50	D 210	5409	5334	163,10
	3410	3350	66,20	D 220 1/2	5675	5600	182,70
	3510	3450	67,40	D 225	5790	5715	185,40
	3610	3550	68,60	D 236	6075	6000	193,30
	3810	3750	73,50	D 240	6171	6096	196,20
	4010	3950	76,90	D 248	6375	6300	202,00
	4060	4000	76,90	D 264	6775	6700	221,80
	4310	4250	82,40	D 270	6933	6858	227,70
	4510	4450	87,80	D 279 1/2	7175	7100	237,20
	4560	4500	87,80	D 295	7575	7500	262,40
	4810	4750	93,10	D 315	8075	8000	281,60
	5060	5000	99,70	D 330	8457	8382	295,50
	5360	5300	108,70	D 335	8575	8500	301,20
	5660	5600	119,40	D 354	9075	9000	328,10
	6060	6000	130,80	D 374	9575	9500	345,80
	6350	6300	139,10	D 394	10075	10000	362,30
	6560	6500	147,60	D 441	11275	11200	406,10
	6760	6700	155,30	D 492	12575	12500	451,00
	7160	7100	166,70	Gewicht/ weight = 0,675 kg/m			
	7560	7500	179,60				
	8060	8000	191,00				
	8560	8500	208,40				
	9060	9000	225,60	<b>Profil / Section 40 x 25 mm E</b>			
	9310	9250	232,80	E 118	3080	3000	163,10
	9560	9500	237,60	E 132	3430	3350	176,90
	10060	10000	253,20	E 157 1/2	4080	4000	207,40
	10460	10400	281,80	E 197	5080	5000	253,80
				E 220 1/2	5680	5600	300,40
				E 236	6080	6000	331,80
				E 248	6380	6300	345,10
				E 279 1/2	7180	7100	400,30
				E 295	7580	7500	429,70
				E 315	8080	8000	457,60
				E 354	9080	9000	527,40
				E 394	10080	10000	584,70
				E 441	11280	11200	659,40
				E 492	12580	12500	731,00
Gewicht/ weight = 0,422 kg/m				Gewicht/ weight = 1,030 kg/m			





XPZ			AVX 10/ 9,5			AVX 11,2 XDA 11,3 *		
LW/LD= Richtlänge pitch length mm	LA= Außenlänge outside length mm	Stück piece  Euro	LW/LD= Richtlänge pitch length mm	LA= Außenlänge outside length mm	Stück piece  Euro		LA= Außenlänge outside length mm	Stück piece  Euro
562	575	6,60	1262	1275	11,90		11,2 x 820	10,20
587	600	6,60	1287	1300	11,90		11,2 x 866	10,20
592	605	6,60	1312	1325	11,90		11,2 x 886	10,20
602	615	6,60	1320	1333	12,20		11,3 x 912	10,20
612	625	6,60	1327	1340	12,20			
622	635	6,60	1337	1350	12,20	*XDA = extra dehnungsarm extra low stretch		
630	643	6,60	1362	1375	12,20			
637	650	6,60	1387	1400	12,40	<b>AVX 11,5</b>		
662	675	7,00	1400	1413	12,40			
670	685	7,00	1412	1425	12,40		LA= Außenlänge outside length mm	Stück piece  Euro
682	695	7,00	1437	1450	12,80		730	10,20
687	700	7,00	1462	1475	12,80		755	10,20
697	710	7,00	1487	1500	13,20		790	10,20
710	725	7,00	1500	1513	13,20	<b>AVX 11,9</b>		
717	730	7,00	1512	1525	13,20			
722	735	7,00	1537	1550	13,70		LA= Außenlänge outside length mm	Stück piece  Euro
737	750	7,00	1562	1575	13,70		650	10,20
750	763	7,50	1587	1600	13,70		710	10,20
762	775	7,50	1600	1613	14,00		740	10,20
772	785	7,50	1612	1625	14,00		768	10,20
787	800	7,50	1637	1650	14,00		775	10,20
800	813	7,50	1662	1675	15,70		793	10,20
812	825	7,50	1687	1700	15,70	<b>AVX 11,9</b>		
825	838	7,70	1700	1713	15,70			
837	850	7,70	1737	1750	16,30		806	10,20
850	864	7,70	1750	1763	16,30		864	10,90
857	870	7,80	1762	1775	16,30		876	10,90
862	875	7,80	1787	1800	16,30		950	10,90
875	888	7,80	1800	1813	16,30		982	10,90
887	900	7,80	1887	1900	17,10		1010	10,90
892	905	8,30	1900	1913	17,10		1042	10,90
900	913	8,30	1937	1950	18,10		1150	12,80
912	925	8,50	2000	2013	18,10		1171	12,80
917	930	8,50	2120	2133	20,00		1183	12,80
922	935	8,50	2240	2253	21,80		1214	12,80
925	940	8,50	2360	2373	22,40			
937	950	8,80	2500	2513	24,90			
947	960	8,80	2650	2663	25,20			
950	965	8,80	2800	2813	27,30			
957	970	8,80	3000	3013	28,40			
962	975	9,20	3150	3163	30,10			
967	980	9,20	3350	3363	31,50			
977	990	9,20	3550	3563	33,40			
987	1000	9,20						
992	1005	9,20						
1000	1013	9,20						
1012	1025	9,70						
1037	1050	9,70						
1047	1060	9,70						
1060	1075	9,70						
1077	1090	9,70						
1087	1100	9,70						
1112	1125	9,70						
1120	1133	11,30						
1137	1150	11,30						
1152	1165	11,30						
1162	1175	11,30						
1180	1193	11,30						
1187	1200	11,30						
1202	1215	11,50						
1212	1225	11,50						
1237	1250	11,50						
1250	1263	11,90						

Gewicht/ weight = 0,065 kg/m

Gewicht/ weight = 0,106 kg/m



XPA			AVX 13/ 12,5			XPB			Profil/Section		
LW/LD= Richtlänge pitch length mm	LA= Außenlänge outside length mm	Stück piece  Euro	LW/LD= Richtlänge pitch length mm	LA= Außenlänge outside length mm	Stück piece  Euro	LW/LD= Richtlänge pitch length mm	LA= Außenlänge outside length mm	Stück piece  Euro			
582	600	9,50	1807	1825	23,20	1250	1272	23,30			
657	675	9,50	1832	1850	23,20	1320	1342	23,80			
682	700	9,50	1857	1875	23,30	1400	1422	25,60			
707	725	9,50	1882	1900	23,40	1450	1472	26,50			
732	750	9,50	1900	1918	23,70	1500	1522	27,40			
757	775	9,50	1907	1925	23,70	1550	1572	28,30			
782	800	9,50	1932	1950	24,00	1600	1622	29,20			
800	818	10,80	1957	1975	24,20	1650	1672	30,30			
807	825	10,80	1982	2000	24,50	1700	1722	31,20			
832	850	10,80	2000	2018	24,80	1750	1772	31,90			
850	868	11,30	2007	2025	24,90	1800	1822	32,80			
857	875	11,30	2032	2050	25,30	1900	1922	34,90			
882	900	11,30	2057	2075	25,40	2000	2022	39,10			
900	918	11,70	2082	2100	25,60	2020	2042	39,40			
907	925	11,70	2120	2138	26,10	2120	2142	41,30			
932	950	11,90	2157	2175	27,20	2240	2262	44,20			
950	968	12,40	2182	2200	27,50	2360	2382	45,90			
957	975	12,40	2232	2250	27,90	2500	2522	48,90			
982	1000	12,60	2240	2258	29,50	2530	2552	49,50			
1000	1018	12,60	2307	2325	29,70	2650	2672	51,80			
1007	1025	12,60	2360	2378	30,50	2680	2702	52,30			
1012	1030	12,60	2382	2400	30,50	2710	2732	52,90			
1032	1050	13,40	2432	2450	31,20	2800	2822	54,70			
1042	1060	13,40	2464	2482	32,30	2840	2862	55,30			
1060	1075	13,50	2482	2500	32,50	2900	2922	56,50			
1082	1100	13,50	2500	2518	32,50	3000	3022	58,50			
1107	1125	13,80	2650	2668	35,00	3150	3172	60,00			
1120	1138	13,80	2800	2818	37,00	3350	3372	64,10			
1127	1145	13,80	3000	3018	39,00	3550	3572	68,40			
1132	1150	14,20	3150	3168	41,10	3750	3772	72,30			
1157	1175	14,20	3350	3368	43,70	4000	4022	76,90			
1180	1200	14,20	3550	3568	47,30	4250	4272	81,90			
1207	1225	15,30	3750	3768	49,90	4500	4522	86,60			
1232	1250	15,30	4000	4018	53,30	4750	4772	91,50			
1250	1268	15,70				5000	5022	96,20			
1257	1275	15,70				Gewicht/ weight = 0,183 kg/m					
1282	1300	16,10									
1307	1325	16,50									
1320	1338	16,90									
1332	1350	16,90									
1357	1375	17,50				<b>XPC</b>	<b>Profil/Section</b>				
1382	1400	17,90				LW/LD= Richtlänge pitch length mm	LA= Außenlänge outside length mm	Stück piece  Euro			
1400	1418	17,90				2000	2030	62,30			
1407	1425	18,50				2120	2150	65,30			
1432	1450	18,50				2240	2270	69,10			
1457	1475	18,70				2360	2390	73,20			
1482	1500	19,30				2500	2530	77,40			
1500	1518	20,00				2650	2680	82,20			
1507	1525	20,00				2800	2830	85,90			
1532	1550	20,80				3000	3030	92,30			
1557	1575	21,00				3150	3180	93,60			
1582	1600	21,20				3350	3380	97,80			
1600	1618	21,70				3550	3580	103,30			
1607	1625	21,70				3750	3780	109,00			
1632	1650	21,80				4000	4030	116,00			
1657	1675	22,00				4250	4280	123,50			
1682	1700	22,30				4500	4530	130,40			
1700	1718	22,60				4750	4780	137,90			
1707	1725	22,60				5000	5030	145,30			
1732	1750	22,70				Gewicht/ weight = 0,340 kg/m					
1757	1775	22,80									
1782	1800	22,90									
1800	1818	23,20									
Gewicht/ weight = 0,111 kg/m											



XPZ				XPA			
LW/LD= Richtlänge pitch length mm	Stück piece Euro	LW/LD= Richtlänge pitch length mm	Stück piece Euro	LW/LD= Richtlänge pitch length mm	Stück piece Euro	LW/LD= Richtlänge pitch length mm	Stück piece Euro
630	11,10	1337	19,50	747	15,40	2430	46,30
637	11,10	1340	19,50	757	15,40	2500	46,30
662	11,10	1362	19,50	782	15,40	2650	49,40
670	11,10	1400	19,50	800	15,40	2800	52,20
687	11,10	1412	20,00	832	16,60	3000	54,90
710	11,10	1420	20,00	850	16,60	3150	59,90
722	11,10	1450	20,00	857	16,60	3350	63,80
730	11,10	1487	20,00	882	16,60	3550	69,40
737	11,10	1500	20,00	900	16,60	3750	73,30
750	11,10	1512	20,30	907	18,30	4000	78,10
760	11,10	1520	20,30	925	18,30		
762	11,10	1537	20,30	932	18,30		
772	11,10	1550	22,10	950	18,30		
787	11,10	1587	22,10	957	18,30		
800	11,10	1600	22,10	975	18,30		
812	11,70	1650	22,10	982	18,30		
837	11,70	1687	22,80	1000	18,30		
850	11,70	1700	22,80	1007	21,20		
862	11,70	1750	22,80	1030	21,20		
875	11,70	1800	23,70	1060	21,20		
887	11,70	1850	24,60	1082	21,20		
900	11,70	1900	25,40	1090	21,20		
912	12,80	1950	26,50	1107	21,20		
925	12,80	2000	27,80	1120	21,20		
937	12,80	2030	28,40	1140	23,20		
950	12,80	2120	28,40	1150	23,20		
962	12,80	2160	30,10	1157	23,20		
975	12,80	2240	31,00	1180	23,20		
980	12,80	2280	31,00	1207	23,20		
987	12,80	2360	32,20	1215	23,20		
1000	12,80	2410	34,60	1232	23,20		
1010	15,10	2500	35,30	1250	23,20		
1012	15,10	2540	35,70	1257	25,40		
1030	15,10	2650	36,70	1282	25,40		
1037	15,10	2690	37,40	1285	25,40		
1060	15,10	2800	39,50	1307	25,40		
1062	15,10	2840	39,50	1320	25,40		
1077	15,10	3000	40,70	1332	26,70		
1080	15,10	3150	42,90	1357	26,70		
1087	15,10	3350	46,20	1360	26,70		
1090	15,10		47,90	1400	26,70		
1112	15,10			1450	28,60		
1120	15,10			1482	28,60		
1137	15,90			1500	28,60		
1140	15,90			1507	29,20		
1150	15,90			1532	29,20		
1162	15,90			1550	29,20		
1180	15,90			1582	29,20		
1187	15,90			1600	29,20		
1200	16,60			1650	32,00		
1202	16,60			1700	32,00		
1212	16,60			1750	33,20		
1237	16,60			1800	33,20		
1250	16,60			1850	34,30		
1262	17,50			1900	35,50		
1270	17,50			1950	37,60		
1280	17,50			2000	38,40		
1285	17,50			2060	39,80		
1287	17,50			2120	39,80		
1312	17,50			2240	42,10		
1320	17,50			2360	43,20		

Gewicht/ weight = 0,065 kg/m

Gewicht/ weight = 0,111 kg/m



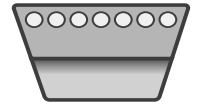

Profil/Section X/ 10 x 6 mm ZX				Profil/Section X/ 13 x 8 mm AX				Profil/Section X/ 13 x 8 mm AX			
Code Nr.	Richtlänge LD	Innenlänge inside length	Stück piece	Code Nr.	Richtlänge LD	Innenlänge inside length	Stück piece	Code Nr.	Richtlänge LD	Innenlänge inside length	Stück piece
	mm	mm	Euro		mm	mm	Euro		mm	mm	Euro
ZX 19	502	480	-	AX 20	538	508	10,20	AX 57	1480	1450	23,80
ZX 19 1/2	522	500	-	AX 22	590	560	10,20	AX 58	1505	1475	23,80
ZX 20 1/3	537	515	-	AX 23	615	585	10,20	AX 59	1530	1500	23,80
ZX 20 3/4	547	525	-	AX 23 1/2	630	600	10,20	AX 60	1555	1525	23,80
ZX 22	582	560	-	AX 24	640	610	11,20	AX 61	1580	1550	23,80
ZX 22 1/2	597	575	-	AX 24 1/2	660	630	11,20	AX 62	1605	1575	23,80
ZX 23 1/4	612	590	-	AX 25	665	635	11,20	AX 63	1630	1600	23,80
ZX 24	622	600	-	AX 25 1/2	680	650	11,20	AX 64	1655	1625	-
ZX 24 1/4	637	615	-	AX 26	690	660	11,20	AX 65	1680	1650	-
ZX 25	652	630	-	AX 26 1/2	700	670	11,20	AX 66	1706	1676	-
ZX 25 1/2	672	650	-	AX 27	716	686	11,20	AX 67	1730	1700	-
ZX 26	682	660	-	AX 27 1/2	730	700	11,20	AX 68	1755	1725	-
ZX 26 1/2	692	670	-	AX 28	740	710	11,70	AX 69	1780	1750	-
ZX 26 3/4	702	680	-	AX 29	760	730	11,70	AX 70	1805	1775	-
ZX 28	732	710	-	AX 29 1/2	780	750	11,70	AX 71	1830	1800	-
ZX 28 1/2	747	725	-	AX 30	797	767	11,70	AX 72	1855	1825	-
ZX 29	752	730	-	AX 30 1/2	805	775	11,70	AX 73	1884	1854	-
ZX 29 1/2	772	750	-	AX 31	817	787	11,70	AX 74	1910	1880	-
ZX 30	787	765	-	AX 31 1/2	830	800	11,70	AX 75	1930	1900	-
ZX 30 1/2	797	775	-	AX 32	843	813	13,90	AX 76	1960	1930	-
ZX 31	812	790	-	AX 32 1/2	855	825	13,90	AX 77	1986	1956	-
ZX 31 1/2	822	800	-	AX 33	871	841	13,90	AX 78	2010	1980	-
ZX 32	842	820	-	AX 33 1/2	880	850	13,90	AX 79	2030	2000	-
ZX 32 1/2	847	825	-	AX 34	893	863	13,90	AX 80	2062	2032	-
ZX 33	862	840	-	AX 34 1/2	905	875	13,90	AX 81	2090	2060	-
ZX 33 1/2	872	850	-	AX 35	919	889	13,90	AX 82	2113	2083	-
ZX 34	887	865	-	AX 35 1/2	930	900	13,90	AX 83	2130	2100	-
ZX 34 1/2	897	875	-	AX 36	944	914	14,90	AX 83 1/2	2150	2120	-
ZX 35 1/2	922	900	-	AX 36 1/2	955	925	14,90	AX 84	2164	2134	-
ZX 36 1/2	947	925	-	AX 37	970	940	14,90	AX 84 1/2	2180	2150	-
ZX 37	962	940	-	AX 37 1/2	980	950	14,90	AX 85	2190	2160	-
ZX 37 1/2	972	950	-	AX 38	995	965	14,90	AX 86	2215	2185	-
ZX 38 1/2	997	975	-	AX 38 1/2	1005	975	14,90				
ZX 39 1/2	1022	1000	-	AX 39	1020	990	14,90				
ZX 40	1038	1016	-	AX 39 1/2	1030	1000	14,90				
ZX 40 1/2	1052	1030	-	AX 40	1040	1016	14,90				
ZX 41	1063	1041	-	AX 40 1/2	1060	1030	14,90				
ZX 41 1/2	1072	1050	-	AX 41	1071	1041	14,90				
ZX 42	1082	1060	-	AX 41 1/2	1080	1050	14,90				
ZX 42 1/2	1102	1080	-	AX 42	1090	1060	14,90				
ZX 43	1122	1100	-	AX 42 1/2	1105	1075	14,90				
ZX 43 1/2	1127	1105	-	AX 43	1120	1090	16,10				
ZX 44	1142	1120	-	AX 43	1130	1100	16,10				
ZX 44 1/2	1154	1132	-	AX 43 1/2	1135	1105	16,10				
ZX 45	1172	1150	-	AX 44	1150	1120	16,10				
ZX 46	1187	1165	-	AX 45	1173	1143	16,10				
ZX 46 1/2	1202	1180	-	AX 45 1/2	1180	1150	16,10				
ZX 47	1216	1200	-	AX 46	1198	1168	16,10				
ZX 47 1/2	1237	1215	-	AX 46 1/2	1210	1180	16,10				
ZX 48 1/2	1247	1225	-	AX 47	1220	1190	16,10				
ZX 49	1272	1250	-	AX 47 1/2	1230	1200	16,10				
ZX 51	1317	1295	-	AX 48	1245	1215	20,50				
ZX 51 1/4	1322	1300	-	AX 48 1/4	1255	1225	20,50				
				AX 48 3/4	1270	1240	20,50				
				AX 49	1280	1250	20,50				
				AX 50	1300	1270	20,50				
				AX 51	1330	1300	20,50				
				AX 52	1350	1320	22,20				
				AX 53	1380	1350	22,20				
				AX 54	1405	1375	22,20				
				AX 55	1430	1400	22,20				
				AX 56	1452	1422	22,20				

Gewicht/ weight = 0,062 kg/m

Gewicht/ weight = 0,099 kg/m

Nicht aufgeführte Preise und Größen auf Anfrage.

Not mentioned prices and sizes on request.

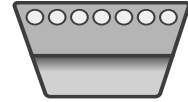

Profil/Section X/ 17 x 11 mm BX				Profil/Section X/ 17 x 11 mm BX				Profil/Section X/ 17 x 11 mm BX			
Code Nr.	Richtlänge LD	Innenlänge inside length	Stück piece	Code Nr.	Richtlänge LD	Innenlänge inside length	Stück piece	Code Nr.	Richtlänge LD	Innenlänge inside length	Stück piece
	mm	mm	Euro		mm	mm	Euro		mm	mm	Euro
BX 22 1/2	610	570	–	BX 65	1690	1650	35,40	BX 140	3590	3550	–
BX 24	655	615	–	BX 66	1716	1676	35,40				
BX 25	670	630	13,90	BX 67	1740	1700	35,40				
BX 25 1/2	690	650	13,90	BX 68	1765	1725	36,10				
BX 26 1/2	710	670	13,90	BX 69	1790	1750	36,10				
BX 27	726	686	13,90	BX 69 1/2	1801	1761	36,10				
BX 28	750	710	13,90	BX 70	1815	1775	36,10				
BX 28 1/2	765	725	13,90	BX 71	1840	1800	36,10				
BX 29 1/2	790	750	15,00	BX 72	1869	1829	38,40				
BX 30	802	762	15,00	BX 73	1890	1850	38,40				
BX 30 1/2	815	775	15,00	BX 74	1920	1880	38,40				
BX 31	827	787	15,00	BX 75	1940	1900	38,40				
BX 31 1/2	840	800	15,00	BX 76	1970	1930	38,40				
BX 32	853	813	18,60	BX 77	1990	1950	38,40				
BX 32 1/2	865	825	18,60	BX 78	2021	1981	38,40				
BX 33	876	836	18,60	BX 79	2040	2000	38,40				
BX 33 1/2	890	850	18,60	BX 80	2072	2032	38,80				
BX 34	904	864	18,60	BX 81	2100	2060	38,80				
BX 34 1/2	915	875	18,60	BX 82	2123	2083	38,80				
BX 35	929	889	18,60	BX 83	2140	2100	38,80				
BX 35 1/2	940	900	18,60	BX 83 1/2	2160	2120	38,80				
BX 36	954	914	18,60	BX 84	2170	2130	44,90				
BX 36 1/2	965	925	18,60	BX 85	2200	2160	44,90				
BX 37	980	940	18,60	BX 86	2225	2185	44,90				
BX 37 1/2	990	950	18,60	BX 86 1/2	2240	2200	44,90				
BX 38	1005	965	18,60	BX 87	2250	2210	44,90				
BX 38 1/2	1015	975	18,60	BX 87 1/2	2260	2220	44,90				
BX 39	1030	990	18,60	BX 88	2280	2240	44,90				
BX 39 1/2	1040	1000	21,00	BX 89	2300	2260	46,30				
BX 40	1056	1016	21,00	BX 90	2326	2286	46,30				
BX 40 1/2	1070	1030	21,00	BX 90 1/2	2340	2300	46,30				
BX 41	1080	1040	21,00	BX 91	2350	2310	46,30				
BX 41 1/2	1090	1050	21,30	BX 92	2370	2330	46,30				
BX 42	1100	1060	21,30	BX 93	2400	2360	46,30				
BX 42 1/2	1115	1075	21,30	BX 94	2420	2380	49,30				
BX 43	1130	1090	21,30	BX 94 1/2	2440	2400	49,30				
BX 43 1/2	1140	1100	21,30	BX 95	2453	2413	49,30				
BX 44	1160	1120	21,30	BX 96	2478	2438	49,30				
BX 45	1190	1150	24,30	BX 96 1/2	2490	2450	49,30				
BX 45 1/2	1203	1163	24,30	BX 97	2505	2465	49,30				
BX 46	1215	1175	24,30	BX 98	2530	2490	49,30				
BX 46 1/2	1220	1180	24,30	BX 98 1/2	2540	2500	49,30				
BX 47	1230	1190	24,30	BX 99	2560	2520	49,30				
BX 47 1/2	1240	1200	24,30	BX 100	2580	2540	49,30				
BX 48	1255	1215	28,10	BX 101	2610	2570	–				
BX 48 1/2	1265	1225	28,10	BX 102	2640	2600	–				
BX 49	1290	1250	28,10	BX 103	2665	2625	–				
BX 50	1315	1275	28,10	BX 104	2690	2650	–				
BX 51	1340	1300	30,60	BX 105	2707	2667	–				
BX 52	1360	1320	30,60	BX 106	2740	2700	–				
BX 53	1390	1350	30,60	BX 108	2790	2750	–				
BX 54	1412	1372	30,60	BX 110	2840	2800	–				
BX 55	1440	1400	30,60	BX 112	2885	2845	–				
BX 56	1462	1422	30,60	BX 114	2940	2900	–				
BX 57	1490	1450	30,60	BX 116	2990	2950	–				
BX 58	1513	1473	32,20	BX 118	3040	3000	–				
BX 59	1540	1500	32,20	BX 120	3088	3048	–				
BX 60	1565	1525	32,20	BX 124	3190	3150	–				
BX 61	1590	1550	32,20	BX 128	3290	3250	–				
BX 62	1615	1575	32,20	BX 132	3390	3350	–				
BX 63	1640	1600	32,20	BX 135	3470	3430	–				
BX 64	1665	1625	35,40	BX 136	3490	3450	–				

Nicht aufgeführte Preise und Größen auf Anfrage.

Not mentioned prices and sizes on request.

Gewicht/ weight = 0,165 kg/m

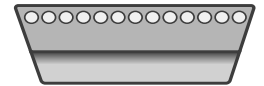

Profil section	Li mm	Winkel angle	Iso-Code Nr.	Stück / piece Euro	Profil section	Li mm	Winkel angle	Iso-Code Nr.	Stück / piece Euro		
<b>13 x 5</b>	468	24		19,60	<b>26 x 8</b>	1082	27	W 25/ 1120	57,60		
	476			19,90		1212		W 25/ 1250	61,80		
	700			21,80		1362		W 25/ 1400	65,20		
	1120			27,60							
<b>17 x 5</b>	426	24	W 16/ 450	24,50	<b>26 x 8</b>	1562		W 25/ 1600	71,70		
	476		W 16/ 500	24,80		<b>28 x 8</b>		600	25		44,30
	536		W 16/ 560	25,50				650		45,00	
	606		W 16/ 630	28,10				700		46,20	
	686		W 16/ 710	29,10				750		47,50	
<b>21 x 6</b>	776	27	W 16/ 800	31,00		800			48,80		
	875		W 16/ 900	32,60		850		51,30			
	976		W 16/ 1000	34,30		900		52,40			
	530		W 20/ 560	31,00		950		54,30			
	600		W 20/ 630	32,60		1000		55,50			
	675		W 20/ 710	36,10		1060		57,50			
<b>22 x 8</b>	770	25	W 20/ 800	37,30		1120			58,40		
	870		W 20/ 900	39,40		1180		61,60			
	970		W 20/ 1000	40,90		1250		63,70			
	1090		W 20/ 1120	46,10		1320		67,00			
	525					1400		69,40			
	550					1500		70,60			
	575					1600		76,60			
	600					1700		84,30			
	610					1800		89,80			
	650					2000		95,00			
<b>23 x 10</b>	675	30			<b>30 x 10</b>	650	27		47,50		
	700					665		48,20			
	750					680		48,40			
	800					700		48,80			
	850					750		49,50			
	900					775		50,10			
	950					800		51,70			
	1000					850		54,30			
	1060					875		54,70			
	1120					900		55,40			
	1180					950		57,40			
	1200					1000		59,40			
	1250					1035		60,20			
	1320					1050		60,90			
<b>26 x 8</b>	1400	27			1073	61,70					
	1500				1120	63,50					
	1600				1175	67,00					
	1700				1185	67,40					
	1800				1200	68,00					
	2000				1320	71,50					
	760				<b>32 x 10</b>	750	51,30				
	813					790	52,60				
<b>26 x 8</b>	833	27	W 25/ 670	44,60		820	W 31,5/ 840	54,40			
	865		W 25/ 695	45,00		850	W 31,5/ 870	55,50			
	935		W 25/ 710	45,70		900	W 31,5/ 900	57,30			
	630		W 25/ 720	45,80		950	W 31,5/ 950	59,00			
	655		W 25/ 750	46,80		1000	W 31,5/ 1000	59,00			
	672					1073	W 31,5/ 1050	61,00			
	680					1100	W 31,5/ 1150	62,80			
	710					1120	W 31,5/ 1121	63,50			
	750					1200	W 31,5/ 1170	64,70			
	762					1250	W 31,5/ 1250	69,90			
<b>26 x 8</b>	800	27	W 25/ 790	47,50		1353	W 31,5/ 1300	70,60			
	850		W 25/ 800	47,80		1400	W 31,5/ 1400	74,80			
	862		W 25/ 840	48,80		1420	W 31,5/ 1450	75,90			
	900		W 25/ 890	51,30		1553	W 31,5/ 1470	77,00			
	962		W 25/ 900	51,40		1750	W 31,5/ 1600	77,70			
	1000		W 25/ 940	52,40		1953	W 31,5/ 1800	84,30			
			W 25/ 1000	54,20			W 31,5/ 2000	89,80			
			W 25/ 1040	55,50							

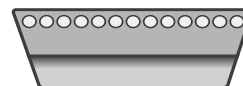

Profil section	Li mm	Winkel angle	Iso-Code Nr.	Stück /piece Euro	Profil section	Li mm	Winkel angle	Iso-Code Nr.	Stück / piece Euro							
36 x 14	1140	30		67,00	52 x 16	1800	28	W 50/ 1875	174,40							
	1720			99,30		1900			183,00							
37 x 10	660	28		58,40		1925		W 50/ 2000	183,00							
	750			58,40		2000			188,70							
	800			60,40	55 x 16	2165	28		200,10							
	850			62,80		2425			232,80							
	900			64,70		1250			136,70							
	950			67,00		1320			139,70							
	1000			68,80		1400			143,60							
	1060			70,60		1500			153,50							
	1120			73,50		1600			160,30							
	1180			76,60		1700			166,70							
	1250			79,50		1800			170,00							
	1320			82,00		1900			173,90							
	1400			86,70		2000			183,00							
	1500			90,30		2240			202,70							
	1600			93,90		2500			222,50							
	1700			99,30		2800			318,40							
	1800			102,80		65 x 20			1706	30	W 63/ 1800	276,00				
	2000			108,20					1906	W 63/ 2000	298,30					
41 x 13	2240	27	W 40/ 990	117,30		2146	W 63/ 2240	355,20								
	2500			128,60		2406		W 63/ 2500	395,00							
	925		W 40/ 1030	81,30	70 x 18	1445	28		251,40							
	970			84,10		1500			260,70							
	1000			86,10		1550			269,50							
	1040			88,50		1600			278,40							
	1060			90,30		1700			284,30							
	1120			92,10		1800			293,50							
1190	95,70	2000	315,50													
	1250		W 40/ 1310	99,30		2240			350,00							
	1340			104,60		2500			382,90							
	1400			107,00		2800			402,40							
	1440			108,90		3150			452,80							
	1600			117,80					W 40/ 1660	117,80						
1740	125,00	W 40/ 1800	125,00													
	1940		W 40/ 2000	132,80												
	2180		W 40/ 2240	139,80												
	47 x 10		1000	28							87,20					
			1120								87,20					
47 x 13	850	28		87,20												
	900			87,20												
	950			88,50												
	1000			90,90												
	1060			94,50												
	1120			98,70												
	1180			101,00												
	1250			104,60												
	1320			107,70												
	1400			118,70												
	1500			120,20												
	1600			125,00												
	1700			130,90												
	1800			134,60												
	2000			143,60												
	2240			151,30												
	2500			165,60												
52 x 16	1180	27	W 50/ 1255	128,50												
	1250		W 50/ 1325	133,50												
	1325		W 50/ 1400	140,20												
	1400		W 50/ 1475	146,10												
	1525		W 50/ 1600	157,80												
	1600		W 50/ 1675	163,80												
	1725		W 50/ 1800	170,90												

Viele weitere Längen und Breiten am Lager.

Many other lengths and widths at stock.

Aufpreis für geschnittene Sonderbreiten: 20 %

Surcharge for cutting special widths: 20 %

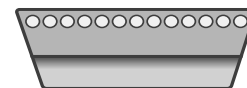

RMA - MPTA Code Nr.	Stück / piece Euro	RMA - MPTA Code Nr.	Stück / piece Euro	RMA - MPTA Code Nr.	Stück / piece Euro
1422 V 235 1422 V 240 1422 V 270 1422 V 290 1422 V 300		2322 V 601 2322 V 661 2322 V 681 2322 V 701 2322 V 801		4430 V 560 4430 V 570 4430 V 578 4430 V 600 4430 V 610	
1422 V 330 1422 V 340 1422 V 360 1422 V 400 1422 V 420		2530 V 500 2530 V 530 2530 V 560 2530 V 600 2530 V 630		4430 V 630 4430 V 652 4430 V 660 4430 V 670 4430 V 690	
1422 V 440 1422 V 460 1422 V 470 1422 V 480 1422 V 540		2530 V 670 2530 V 710 2530 V 750 2530 V 790 2830 V 337		4430 V 700 4430 V 710 4430 V 730 4430 V 750 4430 V 790	
1422 V 600 1422 V 660 1430 V 215 1922 V 277 1922 V 282		2830 V 363 2830 V 366 2830 V 367 2830 V 393 2830 V 396		4430 V 800 4430 V 850	
1922 V 298 1922 V 321 1922 V 332 1922 V 338 1922 V 363		2830 V 422 2926 V 471 2926 V 486 2926 V 521 2926 V 546			
1922 V 381 1922 V 386 1922 V 403 1922 V 426 1922 V 443	auf Anfrage  on request	2926 V 574 2926 V 586 2926 V 606 2926 V 616 2926 V 636	auf Anfrage  on request		auf Anfrage  on request
1922 V 454 1922 V 460 1922 V 484 1922 V 526 1922 V 544		2926 V 646 2926 V 666 2926 V 686 2926 V 726 2926 V 750			
1922 V 604 1922 V 630 1922 V 646 1922 V 666 1922 V 686		2926 V 776 2926 V 786 3226 V 392 3226 V 400 3226 V 433			
1922 V 706 1922 V 721 1922 V 726 1922 V 751 1922 V 756		3226 V 450 3226 V 505 3226 V 545 3226 V 585 3226 V 603			
1926 V 250 1926 V 275 1926 V 290 1926 V 407 1926 V 415		3226 V 650 3226 V 663 3226 V 723 3226 V 783 3226 V 843			
1926 V 427 2230 V 266 2230 V 273 2230 V 275 2230 V 326		3230 V 560 3230 V 585 3230 V 600 3230 V 630 3230 V 670			
2230 V 375 2322 V 329 2322 V 347 2322 V 364 2322 V 396		3230 V 710 3230 V 723 3230 V 750 3230 V 800 3230 V 850			
2322 V 421 2322 V 434 2322 V 441 2322 V 461 2322 V 481		3432 V 450 3432 V 456 3432 V 480 3432 V 528 3432 V 534			
2322 V 486 2322 V 521 2322 V 541		4430 V 530 4430 V 548 4430 V 555			





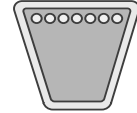

Profil/ Section 3L (3/8")				Profil/ Section 4L (4/8")			
Type	Außenlänge outside length		Stück piece Euro	Type	Außenlänge outside length		Stück piece Euro
	Zoll/ inch	mm			Zoll/ inch	mm	
3L-150	15	381	17,40	4L-170	17	432	18,80
3L-160	16	404	17,40	4L-180	18	457	18,80
3L-170	17	432	17,40	4L-190	19	483	18,80
3L-180	18	457	17,60	4L-200	20	508	18,80
3L-190	19	483	18,00	4L-210	21	533	18,80
3L-200	20	508	20,60	4L-220	22	559	18,80
3L-210	21	533	20,60	4L-230	23	584	18,80
3L-220	22	559	20,60	4L-240	24	610	19,20
3L-230	23	584	20,60	4L-250	25	635	19,60
3L-240	24	610	20,80	4L-260	26	660	20,00
3L-250	25	635	21,20	4L-270	27	686	20,00
3L-260	26	660	21,20	4L-280	28	711	20,20
3L-270	27	686	21,20	4L-290	29	737	21,80
3L-280	28	711	21,20	4L-300	30	762	22,20
3L-290	29	737	21,20	4L-310	31	787	22,60
3L-300	30	762	21,80	4L-320	32	813	22,80
3L-310	31	787	21,80	4L-330	33	838	23,20
3L-320	32	813	21,80	4L-340	34	864	23,40
3L-330	33	838	21,80	4L-350	35	889	23,80
3L-340	34	864	22,20	4L-360	36	914	23,80
3L-350	35	889	23,20	4L-370	37	940	24,20
3L-360	36	914	23,20	4L-380	38	965	24,50
3L-370	37	940	23,20	4L-390	39	991	24,80
3L-380	38	965	23,20	4L-400	40	1016	25,10
3L-390	39	991	24,00	4L-410	41	1041	25,60
3L-400	40	1016	24,40	4L-420	42	1067	25,80
3L-410	41	1041	24,50	4L-430	43	1092	26,10
3L-420	42	1067	24,80	4L-440	44	1118	26,40
3L-430	43	1092	25,00	4L-450	45	1143	26,70
3L-440	44	1118	25,60	4L-460	46	1168	27,00
3L-450	45	1143	25,60	4L-470	47	1194	27,30
3L-460	46	1168	25,60	4L-480	48	1219	27,50
3L-470	47	1194	25,60	4L-490	49	1245	27,90
3L-480	48	1219	25,60	4L-500	50	1270	28,30
3L-490	49	1245	25,80	4L-510	51	1295	28,70
3L-500	50	1270	27,10	4L-520	52	1321	29,30
3L-510	51	1295	28,90	4L-530	53	1346	29,90
3L-520	52	1321	29,50	4L-540	54	1372	30,10
3L-530	53	1346	29,90	4L-550	55	1397	30,50
3L-540	54	1372	30,50	4L-560	56	1422	30,90
3L-550	55	1397	30,90	4L-570	57	1448	31,30
3L-560	56	1422	30,90	4L-580	58	1473	31,70
3L-570	57	1448	31,10	4L-590	59	1499	32,10
3L-580	58	1473	31,50	4L-600	60	1524	32,30
3L-590	59	1499	31,50	4L-610	61	1549	32,70
3L-600	60	1524	31,70	4L-620	62	1575	33,10
3L-610	61	1549	31,90	4L-630	63	1600	33,30
3L-620	62	1575	31,90	4L-640	64	1626	33,70
3L-630	63	1600	32,10	4L-650	65	1651	33,90
3L-690	69	1753	35,70	4L-660	66	1676	34,10
3L-710	71	1803	36,40	4L-670	67	1702	37,50
3L-740	74	1880	53,50	4L-680	68	1727	37,50
3L-750	75	1905	54,10	4L-690	69	1753	38,80
				4L-700	70	1778	39,80
				4L-710	71	1803	40,40
				4L-720	72	1829	40,80
				4L-730	73	1854	48,90
				4L-740	74	1880	49,70
				4L-750	75	1905	49,70
				4L-760	76	1930	49,90
				4L-770	77	1956	49,90
				4L-780	78	1981	50,50
				4L-790	79	2007	51,70
				4L-800	80	2032	52,10

Gewicht/ weight = 0,057 kg/m

Gewicht/ weight = 0,095 kg/m

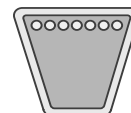

Profil/ Section 4L (4/8")				Profil/ Section 5L (5/8")			
Type	Außenlänge outside length		Stück piece Euro	Type	Außenlänge outside length		Stück piece Euro
	Zoll/ inch	mm			Zoll/ inch	mm	
4L-810	81	2057	52,90	5L-510	51	1295	41,00
4L-820	82	2083	53,70	5L-520	52	1321	41,60
4L-830	83	2108	54,50	5L-530	53	1346	42,20
4L-840	84	2134	55,30	5L-540	54	1372	42,80
4L-850	85	2159	55,90	5L-550	55	1397	43,40
4L-860	86	2184	56,80	5L-560	56	1422	44,00
4L-870	87	2210	57,20	5L-570	57	1448	44,20
4L-880	88	2235	58,40	5L-580	58	1473	44,60
4L-890	89	2261	59,20	5L-590	59	1499	44,90
4L-900	90	2286	59,80	5L-600	60	1524	45,60
4L-910	91	2311	60,80	5L-610	61	1549	46,00
4L-920	92	2337	61,40	5L-620	62	1575	46,20
4L-930	93	2362	62,40	5L-630	63	1600	46,50
4L-940	94	2388	62,60	5L-640	64	1626	47,10
4L-950	95	2413	63,00	5L-650	65	1651	47,70
4L-960	96	2438	63,20	5L-660	66	1676	48,30
4L-970	97	2464	63,40	5L-670	67	1702	49,10
4L-980	98	2489	63,60	5L-680	68	1727	49,50
4L-990	99	2515	63,60	5L-690	69	1753	50,10
4L-1000	100	2540	64,20	5L-700	70	1778	50,70
4L-1050	105	2667	64,60	5L-710	71	1803	51,30
4L-1070	107	2718	64,80	5L-720	72	1829	51,70
4L-1140	114	2896	67,20	5L-730	73	1854	52,50
4L-1170	117	2972	68,30	5L-740	74	1880	53,30
Gewicht/ weight = 0,095 kg/m				5L-750	75	1905	53,90
				5L-760	76	1930	54,50
				5L-770	77	1956	55,00
				5L-780	78	1981	58,00
				5L-790	79	2007	61,60
				5L-800	80	2032	61,80
				5L-810	81	2057	62,40
				5L-820	82	2083	62,80
				5L-830	83	2108	63,40
				5L-840	84	2134	63,40
				5L-850	85	2159	63,40
				5L-860	86	2184	63,40
				5L-870	87	2210	63,80
				5L-880	88	2235	64,40
				5L-890	89	2261	65,10
				5L-900	90	2286	66,00
				5L-910	91	2311	66,40
5L-920	92	2337	66,80				
5L-930	93	2362	67,20				
5L-940	94	2388	67,70				
5L-950	95	2413	68,30				
5L-960	96	2438	68,90				
5L-970	97	2464	69,40				
5L-980	98	2489	69,70				
5L-990	99	2515	70,30				
5L-1000	100	2540	70,90				
5L-1030	103	2616	73,90				
5L-1080	108	2743	77,50				
Gewicht/ weight = 0,143 kg/m							

## Endliche Lochkeilriemen DIN 2216, grün Open ended V - Belting DIN 2216, punched, green

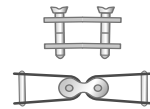
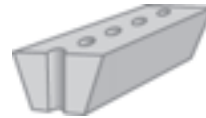

Profil section	Riemen belt Meter Euro	Plattenverbinder plate connectors Stück / piece Euro	Gelenkverbinder link connectors Stück / piece Euro
10	13,00	2,30	Preise auf Anfrage. Prices on request.
13	16,10	2,40	
17	20,90	2,80	
22	39,20	3,70	
Rolle = 50 m		Aufpreis für Anschnitte: 10 %	
roll = 50 m		Surcharge for shorter lengths: 10 %	

## Gliederkeilriemen - Meterware Link Belts - open ended

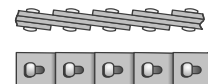
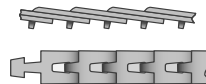

### Power Twist

Profil / Section	Euro / Meter
Z / 10	73,10
A / 13	86,00
B / 17	94,50
C / 22	146,00
D / 32	332,00
AA	107,30
BB	118,10
CC	182,60

Keine Montagezange erforderlich.

Pliers are not necessary.



### Nu-T - Link

Profil / Section	Euro / Meter
Z	108,50
A	117,20
B	127,60
C	199,50
25	294,00
D	455,10
E	526,50



### Super - T - Link

Profil / Section	Euro / Meter
SPZ	163,10
SPA	163,10
SPB	180,40
SPC	277,70



Rolle = 50 m

Aufpreis für Anschnitte: 10 %

roll = 50 m

Surcharge for shorter lengths: 10 %

3M = 3 x 2 mm

5M = 5 x 3 mm

7M = 7 x 5 mm

11M = 11 x 7 mm

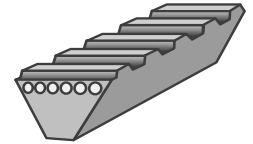

Außenlänge	Profil section 3 M	Profil section 5 M	Profil section 7 M	Profil section 11 M	Außenlänge	Profil section 3 M	Profil section 5 M	Profil section 7 M	Profil section 11 M
outside length mm	Stück piece Euro	Stück piece Euro	Stück piece Euro	Stück piece Euro	outside length mm	Stück piece Euro	Stück piece Euro	Stück piece Euro	Stück piece Euro
180	12,90				670	16,30	22,90	29,10	
185	12,90				690	16,50	23,10	29,20	
190	12,90				710	17,00	24,00	29,40	44,70
195	12,90				730	17,20	24,30	30,10	46,00
200	12,90				750	17,60	24,50	30,40	46,40
206	12,90				775		24,90	30,60	47,10
212	12,90				800		25,40	31,10	48,20
218	12,90				825		25,90	31,20	48,50
224	12,90				850		26,50	31,90	49,50
230	12,90				875		26,90	32,60	50,20
236	12,90				900		27,60	32,80	50,40
243	12,90				925		28,20	33,20	51,70
250	12,90				950		28,70	33,30	52,70
258	12,90				975		29,10	33,90	53,70
265	12,90				1000		29,40	34,30	54,10
272	12,90				1030		30,40	34,90	55,20
280	12,90	19,70			1060		30,80	35,40	55,80
290	12,90	19,70			1090		31,50	35,90	56,70
300	12,90	19,70			1120		32,10	36,70	57,40
307	12,90	19,70			1150		32,80	37,70	58,50
315	12,90	19,70			1180		33,40	37,90	59,70
325	12,90	19,70			1220		34,30	38,90	60,80
335	12,90	19,70			1250		35,00	39,80	61,70
345	12,90	19,70			1280		35,90	40,10	62,30
355	12,90	19,70			1320		36,80	40,50	62,80
365	12,90	19,70			1360		37,70	41,10	64,70
375	12,90	19,70			1400		38,10	42,00	65,90
387	12,90	19,70			1450		39,20	42,90	67,20
400	12,90	19,70			1500		40,10	43,80	68,50
412	12,90	19,70			1550			44,70	70,50
425	12,90	19,70			1600			46,00	72,30
437	12,90	19,70			1650			46,90	74,30
450	12,90	19,70			1700			48,20	75,40
462	13,70	19,70			1750			49,30	78,60
475	13,70	19,70			1800			50,40	79,80
487	13,90	19,70			1850		47,80	58,10	92,00
500	13,90	19,70	28,20		1900			59,60	93,70
515	14,70	19,70	28,20		1950			60,80	97,60
530	14,90	20,30	28,20		2000			62,30	98,80
545	14,90	20,70	28,20		2060			64,00	101,50
560	15,30	20,80	28,20		2120			65,30	103,40
580	15,30	21,40	28,20		2180			68,50	107,10
600	15,30	21,90	28,20		2240			70,50	110,20
615	15,50	22,00	28,20		2300			72,30	112,90
630	15,70	22,40	28,20						
650	16,00	22,60	28,70						
3M Verfügbarkeit auf Anfrage.									
3M availability on request.									



## Neoprene - Keilrippenriemen Neoprene - Ribbed Belts

Profil/Section	PH	PJ	PK	PL	PM	TB2
e =	1,6	2,34	3,56	4,7	9,4	2,0
h =	3,0	3,50	5,50	7,0	13,0	2,2

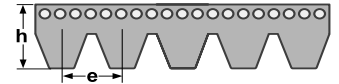

Profil/ Section PJ			Profil/ Section PK			Profil/ Section PL		
Type	Wirklänge pitch length	Rippe/rib Euro	Type	Wirklänge pitch length	Rippe/rib Euro	Type	Wirklänge pitch length	Rippe/rib Euro
130 J	330	1,50	248 K	630	2,20	376 L	955	6,60
140 J	356	1,50	256 K	650	2,30	390 L	991	6,60
150 J	381	1,50	266 K	675	2,30	410 L	1041	6,60
160 J	406	1,50	276 K	700	2,40	423 L	1074	6,60
170 J	432	1,50	287 K	730	2,50	452 L	1150	6,60
180 J	457	1,50	297 K	755	2,50	460 L	1168	6,60
190 J	483	1,50	305 K	775	2,60	470 L	1194	6,60
200 J	508	1,50	315 K	800	2,60	480 L	1219	7,10
220 J	559	1,70	327 K	830	2,70	500 L	1270	7,10
230 J	584	1,70	333 K	845	2,70	510 L	1295	7,10
240 J	610	1,70	343 K	870	2,80	520 L	1321	7,20
260 J	660	1,70	348 K	885	2,80	525 L	1334	7,20
270 J	686	1,70	364 K	925	2,90	540 L	1372	7,50
280 J	711	1,70	374 K	950	3,00	550 L	1397	7,50
285 J	723	1,80	382 K	970	3,10	560 L	1422	7,50
290 J	737	1,80	394 K	1000	3,10	565 L	1435	8,50
300 J	762	1,80	400 K	1015	3,20	580 L	1473	8,50
320 J	813	1,80	407 K	1035	3,20	590 L	1499	8,50
330 J	838	1,80	417 K	1060	3,30	615 L	1562	8,50
340 J	864	1,80	425 K	1080	3,30	635 L	1613	8,80
350 J	889	1,80	451 K	1145	3,50	650 L	1651	9,20
360 J	914	1,80	459 K	1165	3,50	655 L	1664	9,20
376 J	955	1,80	472 K	1200	3,60	675 L	1715	9,40
380 J	965	1,80	484 K	1230	3,70	695 L	1765	9,50
390 J	990	1,80	512 K	1300	3,90	710 L	1803	9,80
400 J	1016	1,80	526 K	1335	4,00	725 L	1842	9,80
415 J	1054	1,80	545 K	1385	4,10	765 L	1943	9,90
430 J	1092	1,90	559 K	1420	4,20	770 L	1956	10,20
450 J	1143	1,90	575 K	1460	4,30	780 L	1981	10,20
460 J	1168	1,90	587 K	1490	4,40	795 L	2019	10,20
470 J	1194	2,00	598 K	1520	4,40	815 L	2070	10,70
480 J	1219	2,00	612 K	1555	4,50	825 L	2096	10,90
490 J	1245	2,00	634 K	1610	4,70	840 L	2134	10,90
500 J	1270	2,00	652 K	1655	4,80	865 L	2197	11,40
510 J	1295	2,00	669 K	1700	4,90	880 L	2235	11,60
520 J	1321	2,30	679 K	1725	4,90	915 L	2324	11,90
530 J	1346	2,30	691 K	1755	5,00	930 L	2362	12,60
540 J	1372	2,30	709 K	1800	5,10	975 L	2477	13,00
550 J	1397	2,30	732 K	1860	5,30	990 L	2515	13,40
560 J	1422	2,30	742 K	1885	5,30	1010 L	2565	13,50
575 J	1461	2,40	748 K	1900	5,40	1065 L	2705	14,00
580 J	1473	2,40	780 K	1980	5,60	1080 L	2743	14,40
610 J	1549	2,40	807 K	2050	5,80	1120 L	2845	15,00
630 J	1600	2,50	819 K	2080	5,80	1140 L	2895	15,10
650 J	1651	2,50	844 K	2145	6,00	1150 L	2921	15,30
655 J	1663	2,50	880 K	2235	6,20	1180 L	2997	15,70
670 J	1702	2,70	917 K	2330	6,50	1215 L	3086	16,10
690 J	1753	2,80	980 K	2490	6,80	1230 L	3124	16,60
700 J	1778	2,80	1006 K	2555	7,00	1270 L	3226	16,90
730 J	1854	3,00				1295 L	3289	17,10
760 J	1930	3,00				1310 L	3327	17,20
770 J	1956	3,10				1375 L	3493	18,40
780 J	1981	3,10				1455 L	3696	19,20
785 J	1994	3,20				1595 L	4051	21,10
795 J	2019	3,20				1650 L	4191	21,90
820 J	2083	3,20				1760 L	4470	23,40
870 J	2210	3,30				1820 L	4623	24,30
920 J	2337	3,90				1980 L	5029	26,30
980 J	2489	3,90				2120 L	5385	28,60
						2400 L	6096	32,50

Wickelpreise und weitere Längen auf Anfrage.

Prices of sleeves and further types on request.

## Neoprene - Keilrippenriemen Neoprene - Ribbed Belts

Profil/Section	PH	PJ	PK	PL	PM	TB2
e =	1,6	2,34	3,56	4,7	9,4	2,0
h =	3,0	3,50	5,50	7,0	13,0	2,2

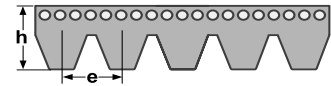

Profil/ Section PM			Profil/ Section PM			Profil/ Section PH		
Type	Wirklänge pitch length	Rippe/rib Euro	Type	Wirklänge pitch length	Rippe/rib Euro	Type	Wirklänge pitch length	Rippe/rib Euro
900 M	2286	36,00	1980 M	5029	76,20	746 H	1895	2,20
940 M	2388	37,00	2130 M	5410	81,90	760 H	1930	2,20
990 M	2515	38,90	2410 M	6121	92,20	768 H	1951	2,20
1060 M	2693	42,80	2710 M	6883	104,10	780 H	1981	2,30
1115 M	2832	43,70	3010 M	7646	114,50	784 H	1992	2,30
1150 M	2921	44,70	3310 M	8408	126,60			
1185 M	3010	45,80	3610 M	9169	139,10			
1230 M	3124	49,00	3910 M	9931	148,90			
1310 M	3327	52,60	4210 M	10693	159,30			
1390 M	3531	55,70	4810 M	12217	181,20			
1470 M	3734	57,30	5410 M	13741	203,60			
1610 M	4089	63,00	6010 M	15266	226,00			
1650 M	4191	63,60	6600 M	16748	248,40			
1760 M	4470	67,80						
1830 M	4648	71,90						

## Polyurethan - Keilrippenriemen Polyurethane - Ribbed Belts

Profil/ Section JPU			Profil/ Section TB2					
Type	Wirklänge pitch length	Rippe/rib Euro	Type	Wirklänge pitch length	Rippe/rib Euro			
JPU 220	220	2,30	156 TB2	156	2,10			
JPU 271	271	2,30	170 TB2	170	2,10			
JPU 275	275	2,30	200 TB2	200	2,10			
JPU 278	278	2,30	220 TB2	220	2,10			
JPU 283	283	2,30	231 TB2	231	2,10			
JPU 288	288	2,40	248 TB2	248	2,10			
JPU 304	304	2,40	266 TB2	266	2,10			
JPU 330	330	2,40	295 TB2	295	2,10			
JPU 345	345	2,40	310 TB2	310	2,10			
JPU 356	356	2,40	327 TB2	327	2,10			
JPU 381	381	2,40	330 TB2	330	2,10			
JPU 392	392	2,40	345 TB2	345	2,10			
JPU 406	406	2,40	360 TB2	360	2,10			
JPU 432	432	2,40	380 TB2	380	2,10			
JPU 444	444	2,40	390 TB2	390	2,20			
JPU 457	457	2,40	400 TB2	400	2,20			
JPU 483	483	2,40	430 TB2	430	2,20			
JPU 508	508	2,50	480 TB2	480	2,20			
JPU 558	558	2,50	510 TB2	510	2,20			
JPU 610	610	2,50	526 TB2	526	2,20			
JPU 660	660	2,50	535 TB2	535	2,20			
JPU 681	681	2,60	598 TB2	598	2,20			
JPU 711	711	2,60	630 TB2	630	2,20			
JPU 762	762	2,60	660 TB2	660	2,20			
JPU 864	864	2,70	675 TB2	675	2,20			
JPU 914	914	2,90	725 TB2	725	2,30			
JPU 953	953	3,00	770 TB2	770	2,40			
JPU 1010	1010	3,20	1186 TB2	1186	3,20			
JPU 1086	1086	3,20						
JPU 1120	1120	3,60						
JPU 1163	1163	3,60						
JPU 1202	1202	3,60						
JPU 1239	1239	3,60						
JPU 1268	1268	4,00						
JPU 1397	1397	4,00						

Wickelpreise und weitere Längen auf Anfrage.

Prices of sleeves and further types on request.

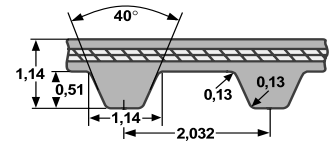

### Type MXL - Teilung/ Pitch 2,032 mm

		Zoll / Inch mm	Breite / width	Breite / width	Breite / width	
		Zoll / Inch	1/8 3,175	3/16 4,763	1/4 6,35	
			012	019	025	
	Wirklänge pitch length		Zähne teeth	Stück piece	Stück piece	Stück piece
	Zoll / inch	mm		Euro	Euro	Euro
44 MXL	3,52	89,41	44	1,30	1,80	2,00
45 MXL	3,60	91,44	45	1,30	1,80	2,00
48 MXL	3,84	97,54	48	1,30	1,80	2,00
50 MXL	4,00	101,60	50	1,30	1,80	2,00
52 MXL	4,16	105,66	52	1,30	1,80	2,00
53 MXL	4,25	107,97	53	1,30	1,80	2,00
54 MXL	4,32	109,73	54	1,30	1,80	2,00
55 MXL	4,64	117,76	55	1,30	1,80	2,00
56 MXL	4,48	113,79	56	1,30	1,80	2,00
57 MXL	4,56	115,82	57	1,40	1,80	2,20
59 MXL	4,72	119,89	59	1,40	1,80	2,20
60 MXL	4,80	121,92	60	1,40	1,80	2,20
61 MXL	4,88	123,95	61	1,40	1,80	2,20
62 MXL	4,96	125,98	62	1,40	1,80	2,20
63 MXL	5,04	128,02	63	1,40	1,80	2,20
64 MXL	5,12	130,05	64	1,40	1,80	2,20
65 MXL	5,20	132,08	65	1,40	1,80	2,20
67 MXL	5,36	136,14	67	1,40	1,80	2,20
68 MXL	5,44	138,18	68	1,40	1,80	2,20
69 MXL	5,52	140,21	69	1,40	1,80	2,20
70 MXL	5,60	142,24	70	1,40	1,80	2,20
71 MXL	5,68	144,27	71	1,40	1,80	2,20
72 MXL	5,76	146,30	72	1,40	1,80	2,20
73 MXL	5,84	148,34	73	1,40	1,80	2,20
74 MXL	5,92	150,37	74	1,40	1,80	2,20
75 MXL	6,00	152,40	75	1,40	1,80	2,20
76 MXL	6,08	154,43	76	1,40	1,80	2,20
77 MXL	6,16	156,46	77	1,40	1,80	2,20
78 MXL	6,24	158,50	78	1,40	1,80	2,20
79 MXL	6,32	160,53	79	1,40	1,80	2,20
80 MXL	6,40	162,56	80	1,40	1,90	2,20
82 MXL	6,56	166,62	82	1,40	1,90	2,20
83 MXL	6,64	168,66	83	1,40	1,90	2,20
85 MXL	6,80	172,72	85	1,40	1,90	2,20
86 MXL	6,88	174,75	86	1,40	1,90	2,20
87 MXL	6,96	176,78	87	1,40	1,90	2,20
88 MXL	7,04	178,82	88	1,40	1,90	2,20
90 MXL	7,20	182,88	90	1,40	1,90	2,20
91 MXL	7,28	184,91	91	1,40	1,90	2,20
92 MXL	7,36	186,94	92	1,40	1,90	2,20
93 MXL	7,44	188,98	93	1,40	1,90	2,20
94 MXL	7,52	191,01	94	1,40	1,90	2,20
95 MXL	7,60	193,04	95	1,40	1,90	2,20
96 MXL	7,68	195,07	96	1,40	1,90	2,20
97 MXL	7,76	197,10	97	1,40	1,90	2,20
98 MXL	7,84	199,14	98	1,40	1,90	2,20
99 MXL	7,92	201,17	99	1,40	1,90	2,20
100 MXL	8,00	203,20	100	1,40	1,90	2,20
101 MXL	8,08	205,23	101	1,40	1,90	2,20
102 MXL	8,16	207,26	102	1,40	1,90	2,20
103 MXL	8,24	209,30	103	1,40	1,90	2,20
104 MXL	8,32	211,33	104	1,40	1,90	2,20
105 MXL	8,40	213,36	105	1,40	1,90	2,20
106 MXL	8,48	215,39	106	1,40	1,90	2,20
108 MXL	8,64	219,46	108	1,50	2,00	2,20
109 MXL	8,72	221,49	109	1,70	2,00	2,30
110 MXL	9,19	233,52	110	1,70	2,00	2,30
112 MXL	8,96	227,58	112	1,70	2,00	2,30
114 MXL	9,12	231,65	114	1,70	2,00	2,30
115 MXL	9,20	233,68	115	1,70	2,00	2,30
118 MXL	9,44	239,78	118	1,70	2,20	2,30

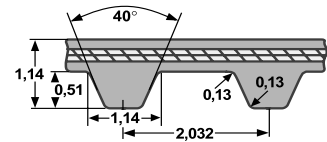

### Type MXL - Teilung/ Pitch 2,032 mm

		Zoll / Inch mm	Breite / width		Breite / width		Breite / width	
		Zoll / Inch	1/8 3,175 012	3/16 4,763 019	1/4 6,35 025			
	Wirklänge pitch length		Zähne teeth	Stück piece Euro	Stück piece Euro	Stück piece Euro		
	Zoll / inch	mm						
119 MXL	9,52	241,81	119	1,70	2,20	2,30		
120 MXL	9,60	243,84	120	1,70	2,20	2,30		
121 MXL	9,68	245,87	121	1,70	2,20	2,30		
122 MXL	9,76	247,90	122	1,70	2,20	2,30		
123 MXL	9,84	249,94	123	1,70	2,20	2,30		
124 MXL	9,92	251,97	124	1,70	2,20	2,30		
125 MXL	10,00	254,00	125	1,70	2,20	2,30		
126 MXL	10,08	256,03	126	1,70	2,20	2,30		
127 MXL	10,16	258,06	127	1,70	2,20	2,30		
128 MXL	10,24	260,10	128	1,70	2,20	2,30		
129 MXL	10,32	262,13	129	1,70	2,20	2,30		
130 MXL	10,40	264,16	130	1,70	2,20	2,30		
131 MXL	10,48	266,19	131	1,70	2,20	2,30		
132 MXL	10,56	268,22	132	1,70	2,20	2,30		
134 MXL	10,72	272,29	134	1,70	2,20	2,30		
135 MXL	10,80	274,32	135	1,80	2,20	2,40		
137 MXL	10,96	278,38	137	1,80	2,20	2,40		
138 MXL	11,04	280,42	138	1,80	2,20	2,40		
140 MXL	11,20	284,48	140	1,80	2,20	2,40		
142 MXL	11,36	288,54	142	1,80	2,20	2,40		
144 MXL	11,52	292,61	144	1,80	2,20	2,40		
145 MXL	11,60	294,64	145	1,80	2,20	2,40		
146 MXL	11,68	296,67	146	1,80	2,20	2,40		
148 MXL	11,84	300,74	148	1,80	2,20	2,40		
150 MXL	12,00	304,80	150	1,80	2,20	2,40		
151 MXL	12,08	306,83	151	1,80	2,20	2,40		
155 MXL	12,40	314,96	155	1,80	2,20	2,40		
158 MXL	12,64	321,06	158	1,80	2,20	2,40		
159 MXL	12,72	323,09	159	1,80	2,20	2,40		
160 MXL	12,80	325,12	160	1,80	2,20	2,40		
162 MXL	12,96	329,18	162	1,80	2,20	2,40		
164 MXL	13,12	333,25	164	1,80	2,20	2,40		
165 MXL	13,20	335,28	165	1,80	2,20	2,40		
169 MXL	13,52	343,41	169	1,80	2,20	2,40		
170 MXL	13,60	345,44	170	1,80	2,20	2,40		
175 MXL	14,00	355,60	175	1,80	2,30	2,50		
177 MXL	14,16	359,67	177	1,80	2,30	2,50		
180 MXL	14,40	365,76	180	1,80	2,30	2,50		
184 MXL	14,72	373,89	184	2,00	2,40	2,70		
188 MXL	15,04	382,02	188	2,00	2,40	2,70		
190 MXL	15,20	386,08	190	2,00	2,40	2,70		
192 MXL	15,36	390,14	192	2,20	2,40	2,70		
195 MXL	15,60	396,24	195	2,20	2,40	2,70		
196 MXL	15,68	398,27	196	2,20	2,40	2,70		
200 MXL	16,00	406,40	200	2,20	2,40	2,70		
204 MXL	16,32	414,53	204	2,20	2,50	2,80		
205 MXL	16,40	416,56	205	2,20	2,50	2,80		
210 MXL	16,80	426,72	210	2,20	2,50	2,80		
212 MXL	16,96	430,78	212	2,20	2,50	2,80		
215 MXL	17,20	436,88	215	2,20	2,50	2,80		
220 MXL	17,60	447,04	220	2,20	2,50	2,80		
221 MXL	17,68	449,07	221	2,20	2,50	2,80		
222 MXL	17,76	451,10	222	2,30	2,50	2,80		
224 MXL	17,92	455,17	224	2,30	2,50	2,80		
225 MXL	17,99	457,00	225	2,30	2,50	2,80		
226 MXL	18,08	459,23	226	2,30	2,50	3,00		
228 MXL	18,24	463,30	228	2,30	2,50	3,00		
230 MXL	18,40	467,36	230	2,30	2,50	3,00		
232 MXL	18,56	471,42	232	2,30	2,50	3,00		
234 MXL	18,72	475,49	234	2,30	2,50	3,00		
236 MXL	18,88	479,55	236	2,30	2,50	3,00		

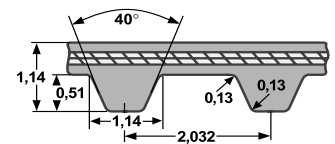

### Type MXL - Teilung/ Pitch 2,032 mm

			Zoll / Inch mm	Breite / width 1/8 3,175	Breite / width 3/16 4,763	Breite / width 1/4 6,35
			Zoll / Inch	012	019	025
	Wirklänge pitch length		Zähne teeth	Stück piece Euro	Stück piece Euro	Stück piece Euro
	Zoll/ inch	mm				
239 MXL	19,12	485,65	239	2,30	2,50	3,00
240 MXL	19,20	487,68	240	2,30	2,50	3,00
245 MXL	19,60	497,84	245	2,30	2,50	3,00
248 MXL	19,84	503,94	248	2,30	2,50	3,00
249 MXL	19,92	505,97	249	2,40	2,70	3,10
250 MXL	20,00	508,00	250	2,40	2,70	3,10
251 MXL	20,08	510,03	251	2,40	2,70	3,10
255 MXL	20,40	518,16	255	2,40	2,70	3,10
256 MXL	20,48	520,19	256	2,40	2,70	3,10
260 MXL	20,80	528,32	260	2,50	2,80	3,20
262 MXL	20,96	532,38	262	2,50	2,80	3,20
265 MXL	21,20	538,48	265	2,50	2,80	3,20
268 MXL	21,44	544,58	268	2,50	2,80	3,20
271 MXL	21,68	550,67	271	2,50	2,80	3,20
273 MXL	21,84	554,74	273	2,50	2,80	3,20
275 MXL	22,00	558,80	275	2,50	2,80	3,20
280 MXL	22,40	568,96	280	2,50	2,80	3,20
281 MXL	22,48	570,99	281	2,70	2,80	3,30
285 MXL	22,80	579,12	285	2,70	2,80	3,30
288 MXL	23,04	585,22	288	2,70	2,80	3,30
290 MXL	23,20	589,28	290	2,70	2,80	3,30
295 MXL	23,60	599,44	295	2,70	2,80	3,30
297 MXL	23,76	603,50	297	2,70	2,80	3,30
300 MXL	24,00	609,60	300	2,70	2,80	3,30
305 MXL	24,40	619,76	305	2,70	2,80	3,30
308 MXL	24,64	625,86	308	2,70	2,80	3,30
310 MXL	24,80	629,92	310	2,70	2,80	3,30
312 MXL	24,96	633,98	312	2,70	3,00	3,40
315 MXL	25,20	640,08	315	2,70	3,00	3,40
318 MXL	25,44	646,18	318	2,80	3,10	3,80
320 MXL	25,60	650,24	320	2,80	3,10	3,80
323 MXL	25,84	656,34	323	2,80	3,10	3,80
326 MXL	26,08	662,43	326	2,80	3,10	3,80
328 MXL	26,24	666,50	328	2,80	3,10	3,80
330 MXL	26,40	670,56	330	2,80	3,10	3,80
332 MXL	26,56	674,62	332	2,80	3,10	3,80
334 MXL	26,72	678,69	334	2,80	3,10	3,80
336 MXL	26,88	682,75	336	2,80	3,10	3,80
337 MXL	26,96	684,78	337	2,80	3,10	3,80
347 MXL	27,76	705,10	347	2,80	3,10	3,80
350 MXL	28,00	711,20	350	2,80	3,20	3,80
354 MXL	28,32	719,33	354	2,80	3,20	3,80
355 MXL	28,40	721,36	355	2,80	3,20	3,80
358 MXL	28,64	727,46	358	2,80	3,20	3,80
359 MXL	28,72	729,49	359	2,80	3,20	3,80
360 MXL	28,80	731,52	360	2,80	3,20	3,80
364 MXL	29,12	739,65	364	2,80	3,20	3,80
365 MXL	29,20	741,68	365	2,80	3,20	3,80
371 MXL	29,68	753,87	371	3,10	3,30	4,00
372 MXL	29,76	755,90	372	3,10	3,30	4,00
380 MXL	30,40	772,16	380	3,10	3,30	4,00
388 MXL	31,04	788,42	388	3,10	3,30	4,00
397 MXL	31,76	806,70	397	3,10	3,30	4,00
400 MXL	32,00	812,80	400	3,10	3,30	4,00
402 MXL	32,16	816,86	402	3,20	3,80	4,10
405 MXL	32,40	822,96	405	3,20	3,80	4,10
410 MXL	32,80	833,12	410	3,20	3,80	4,10
413 MXL	33,04	839,22	413	3,20	3,80	4,10
425 MXL	34,00	863,60	425	3,20	3,80	4,10
431 MXL	34,48	875,79	431	3,20	3,80	4,10
434 MXL	34,72	881,89	434	3,20	3,80	4,10

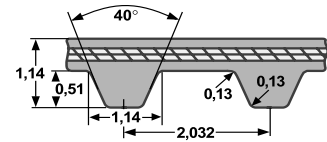

### Type MXL - Teilung/ Pitch 2,032 mm

	Wirklänge pitch length Zoll/ inch   mm		Zähne teeth Zoll/ Inch	Breite/width		Breite/width		Breite/width	
				1/8	3/16	3/16	1/4		
				3,175	4,763	4,763	6,35		
			Stück piece Euro	Stück piece Euro	Stück piece Euro	Stück piece Euro	Stück piece Euro	Stück piece Euro	
435 MXL	34,80	883,92	435	3,30	3,80	3,80	4,20	4,20	4,20
440 MXL	35,20	894,08	440	3,30	3,80	3,80	4,20	4,20	4,20
448 MXL	35,84	910,34	448	3,30	3,80	3,80	4,20	4,20	4,20
453 MXL	32,30	820,50	453	3,30	3,80	3,80	4,20	4,20	4,20
464 MXL	37,12	942,85	464	3,60	4,00	4,00	4,50	4,50	4,50
468 MXL	37,44	950,98	468	3,60	4,00	4,00	4,50	4,50	4,50
473 MXL	37,84	961,14	473	3,60	4,00	4,00	4,50	4,50	4,50
475 MXL	38,00	965,20	475	3,60	4,00	4,00	4,50	4,50	4,50
480 MXL	38,40	975,36	480	3,60	4,00	4,00	4,50	4,50	4,50
487 MXL	38,96	989,58	487	3,60	4,00	4,00	4,50	4,50	4,50
493 MXL	39,44	1001,78	493	3,60	4,00	4,00	4,50	4,50	4,50
498 MXL	39,84	1011,94	498	3,60	4,00	4,00	4,50	4,50	4,50
500 MXL	40,00	1016,00	500	3,60	4,00	4,00	4,50	4,50	4,50
516 MXL	41,28	1048,51	516	3,80	4,10	4,10	4,60	4,60	4,60
522 MXL	41,76	1060,70	522	3,80	4,10	4,10	4,60	4,60	4,60
524 MXL	41,92	1064,77	524	3,80	4,20	4,20	4,80	4,80	4,80
525 MXL	42,00	1066,80	525	3,80	4,20	4,20	4,80	4,80	4,80
535 MXL	42,80	1087,12	535	4,00	4,30	4,30	5,10	5,10	5,10
550 MXL	44,00	1117,60	550	4,00	4,30	4,30	5,10	5,10	5,10
591 MXL	47,28	1200,91	591	4,60	5,40	5,40	6,00	6,00	6,00
612 MXL	48,96	1243,58	612	4,60	5,40	5,40	6,00	6,00	6,00
665 MXL	53,20	1351,28	665	4,60	5,40	5,40	6,00	6,00	6,00

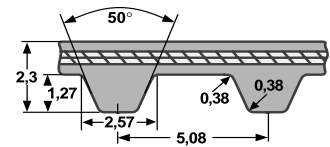

### Type XL - Teilung/ Pitch 5,08 mm

	Wirklänge pitch length Zoll/ inch   mm		Zähne teeth Zoll/ Inch	Breite/width		Breite/width		Breite/width		Breite/width	
				1/4	5/16	3/8	1/2	3/4	1		
				6,35	7,94	9,53	12,7	19,05	25,4		
			Stück piece Euro	Stück piece Euro	Stück piece Euro	Stück piece Euro	Stück piece Euro	Stück piece Euro	Stück piece Euro	Stück piece Euro	
50 XL	5,0	127,0	25	2,00	2,30	2,50	3,30	4,50	6,00	6,00	
54 XL	5,4	137,2	27	2,00	2,30	2,50	3,30	4,50	6,00	6,00	
60 XL	6,0	152,40	30	2,00	2,30	2,50	3,30	4,50	6,00	6,00	
64 XL	6,4	162,56	32	2,00	2,50	2,80	3,40	4,50	6,00	6,00	
68 XL	6,8	172,72	34	2,00	2,50	2,80	3,40	4,50	6,00	6,00	
70 XL	7,0	177,80	35	2,00	2,50	2,80	3,40	4,50	6,00	6,00	
72 XL	7,2	182,88	36	2,20	2,50	2,80	3,40	5,10	6,30	6,30	
74 XL	7,4	187,96	37	2,20	2,50	2,80	3,40	5,10	6,30	6,30	
76 XL	7,6	193,04	38	2,20	2,50	2,80	3,40	5,10	6,30	6,30	
78 XL	7,8	198,12	39	2,20	2,50	2,80	3,40	5,10	6,30	6,30	
80 XL	8,0	203,20	40	2,20	2,50	2,80	3,40	5,10	6,30	6,30	
84 XL	8,4	213,36	42	2,20	2,70	3,00	3,60	5,20	6,40	6,40	
88 XL	8,8	223,52	44	2,20	2,70	3,00	3,60	5,20	6,40	6,40	
90 XL	9,0	228,60	45	2,20	2,70	3,00	3,60	5,20	6,40	6,40	
92 XL	9,2	233,68	46	2,40	2,80	3,00	3,80	5,40	6,60	6,60	
94 XL	9,4	238,76	47	2,40	2,80	3,00	3,80	5,40	6,60	6,60	
96 XL	9,6	243,84	48	2,40	2,80	3,00	3,80	5,40	6,60	6,60	
98 XL	9,8	248,92	49	2,40	2,80	3,00	3,80	5,40	6,60	6,60	
100 XL	10,0	254,00	50	2,40	2,80	3,00	3,80	5,40	6,60	6,60	
102 XL	10,2	259,08	51	2,40	2,80	3,10	3,90	5,40	6,90	6,90	
104 XL	10,4	264,16	52	2,40	2,80	3,10	3,90	5,40	6,90	6,90	
106 XL	10,6	269,24	53	2,40	2,80	3,10	3,90	5,40	6,90	6,90	
108 XL	10,8	274,32	54	2,40	2,80	3,10	3,90	5,40	6,90	6,90	
110 XL	11,0	279,40	55	2,40	2,80	3,10	3,90	5,40	6,90	6,90	

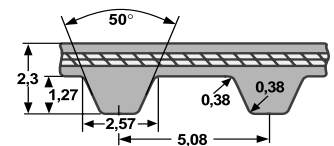

### Type XL - Teilung/ Pitch 5,08 mm

			Zoll/ inch mm Zoll/ inch	Breite/width ¼ 6,35 025	Breite/width 5/16 7,94 031	Breite/width 3/8 9,53 037	Breite/width 1/2 12,7 050	Breite/width ¾ 19,05 075	Breite/width 1 25,4 100
	Wirklänge pitch length		Zähne teeth	Stück piece Euro	Stück piece Euro	Stück piece Euro	Stück piece Euro	Stück piece Euro	Stück piece Euro
	Zoll/ inch	mm							
112 XL	11,2	284,48	56	2,50	2,80	3,20	4,00	5,50	7,10
114 XL	11,4	289,56	57	2,50	2,80	3,20	4,00	5,50	7,10
116 XL	11,6	294,64	58	2,50	2,80	3,20	4,00	5,50	7,10
118 XL	11,8	299,72	59	2,50	2,80	3,20	4,00	5,50	7,10
120 XL	12,0	304,80	60	2,50	2,80	3,20	4,00	5,50	7,10
122 XL	12,2	309,88	61	2,50	3,00	3,30	4,10	5,60	7,40
124 XL	12,4	314,96	62	2,50	3,00	3,30	4,10	5,60	7,40
126 XL	12,6	320,04	63	2,50	3,00	3,30	4,10	5,60	7,40
128 XL	12,8	325,12	64	2,50	3,00	3,30	4,10	5,60	7,40
130 XL	13,0	330,20	65	2,50	3,00	3,30	4,10	5,60	7,40
132 XL	13,2	335,28	66	2,70	3,00	3,40	4,10	6,00	7,50
134 XL	13,4	340,36	67	2,70	3,00	3,40	4,10	6,00	7,50
136 XL	13,6	345,44	68	2,70	3,00	3,40	4,10	6,00	7,50
138 XL	13,8	350,52	69	2,70	3,00	3,40	4,10	6,00	7,50
140 XL	14,0	355,60	70	2,70	3,00	3,40	4,10	6,00	7,50
142 XL	14,2	360,68	71	2,80	3,10	3,40	4,30	6,00	7,70
144 XL	14,4	365,76	72	2,80	3,10	3,40	4,30	6,00	7,70
146 XL	14,6	370,84	73	2,80	3,10	3,40	4,30	6,00	7,70
148 XL	14,8	375,92	74	2,80	3,10	3,40	4,30	6,00	7,70
150 XL	15,0	381,00	75	2,80	3,10	3,40	4,30	6,00	7,70
152 XL	15,2	386,08	76	2,80	3,10	3,40	4,40	6,30	8,20
154 XL	15,4	391,16	77	2,80	3,10	3,40	4,40	6,30	8,20
156 XL	15,6	396,24	78	2,80	3,10	3,40	4,40	6,30	8,20
158 XL	15,8	401,32	79	2,80	3,10	3,40	4,40	6,30	8,20
160 XL	16,0	406,40	80	2,80	3,10	3,40	4,40	6,30	8,20
162 XL	16,2	411,48	81	2,80	3,20	3,60	4,50	6,40	8,20
164 XL	16,4	416,56	82	2,80	3,20	3,60	4,50	6,40	8,20
166 XL	16,6	421,64	83	2,80	3,20	3,60	4,50	6,40	8,20
168 XL	16,8	426,72	84	2,80	3,20	3,60	4,50	6,40	8,20
170 XL	17,0	431,80	85	2,80	3,20	3,60	4,50	6,40	8,20
172 XL	17,2	436,88	86	3,00	3,30	3,80	4,50	6,50	8,30
174 XL	17,4	441,96	87	3,00	3,30	3,80	4,50	6,50	8,30
176 XL	17,6	447,04	88	3,00	3,30	3,80	4,50	6,50	8,30
178 XL	17,8	452,12	89	3,00	3,30	3,80	4,50	6,50	8,30
180 XL	18,0	457,20	90	3,00	3,30	3,80	4,50	6,50	8,30
182 XL	18,2	462,28	91	3,00	3,30	3,90	4,60	6,60	8,70
184 XL	18,4	467,36	92	3,00	3,30	3,90	4,60	6,60	8,70
188 XL	18,8	477,52	94	3,00	3,30	3,90	4,60	6,60	8,70
190 XL	19,0	482,60	95	3,00	3,30	3,90	4,60	6,60	8,70
192 XL	19,2	487,68	96	3,10	3,40	3,90	4,80	6,90	8,80
194 XL	19,4	492,76	97	3,10	3,40	3,90	4,80	6,90	8,80
196 XL	19,6	497,84	98	3,10	3,40	3,90	4,80	6,90	8,80
198 XL	19,8	502,92	99	3,10	3,40	3,90	4,80	6,90	8,80
200 XL	20,0	508,00	100	3,10	3,40	3,90	4,80	6,90	8,80
202 XL	20,2	513,08	101	3,10	3,40	4,00	5,10	7,10	9,00
204 XL	20,4	518,16	102	3,10	3,40	4,00	5,10	7,10	9,00
206 XL	20,6	523,24	103	3,10	3,40	4,00	5,10	7,10	9,00
208 XL	20,8	528,32	104	3,10	3,40	4,00	5,10	7,10	9,00
210 XL	21,0	533,40	105	3,10	3,40	4,00	5,10	7,10	9,00
212 XL	21,2	538,48	106	3,20	3,40	4,10	5,30	7,30	9,50
214 XL	21,4	543,56	107	3,20	3,40	4,10	5,30	7,30	9,50
216 XL	21,6	548,64	108	3,20	3,40	4,10	5,30	7,30	9,50
220 XL	22,0	558,80	110	3,20	3,40	4,10	5,30	7,30	9,50
222 XL	22,2	563,88	111	3,30	3,60	4,10	5,40	7,40	9,50
224 XL	22,4	568,96	112	3,30	3,60	4,10	5,40	7,40	9,50
228 XL	22,8	579,12	114	3,30	3,60	4,10	5,40	7,40	9,50
230 XL	23,0	584,20	115	3,30	3,60	4,10	5,40	7,40	9,50
234 XL	23,4	594,36	117	3,30	3,80	4,30	5,40	7,50	9,60
236 XL	23,6	599,44	118	3,30	3,80	4,30	5,40	7,50	9,60
240 XL	24,0	609,60	120	3,30	3,80	4,30	5,40	7,50	9,60
244 XL	24,4	619,76	122	3,40	3,90	4,30	5,50	7,70	10,10

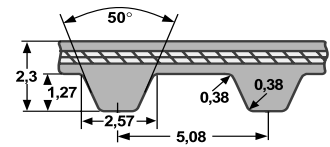

### Type XL - Teilung/ Pitch 5,08 mm

			Zoll/ Inch mm	Zoll/ Inch	Breite/width 1/4 6,35	Breite/width 5/16 7,94	Breite/width 3/8 9,53	Breite/width 1/2 12,7	Breite/width 3/4 19,05	Breite/width 1 25,4
Wirklänge pitch length			Zähne teeth	Stück piece	Stück piece	Stück piece	Stück piece	Stück piece	Stück piece	Stück piece
Zoll/ inch	mm	Zoll/ inch	Euro	Euro	Euro	Euro	Euro	Euro	Euro	Euro
248 XL	24,8	629,92	124	3,40	3,90	4,30	5,50	7,70	10,10	10,10
250 XL	25,0	635,00	125	3,40	3,90	4,30	5,50	7,70	10,10	10,10
260 XL	26,0	660,40	130	3,40	3,90	4,40	5,60	7,80	10,20	10,20
262 XL	26,2	665,48	131	3,40	4,00	4,40	5,60	8,20	10,30	10,30
266 XL	26,6	675,64	133	3,40	4,00	4,40	5,60	8,20	10,30	10,30
270 XL	27,0	685,80	135	3,40	4,00	4,40	5,60	8,20	10,30	10,30
276 XL	27,6	701,04	138	3,60	4,00	4,50	5,90	8,20	10,70	10,70
280 XL	28,0	711,20	140	3,60	4,00	4,50	5,90	8,20	10,70	10,70
282 XL	28,2	716,28	141	3,80	4,10	4,50	5,90	8,30	11,10	11,10
290 XL	29,0	736,60	145	3,80	4,10	4,50	5,90	8,30	11,10	11,10
300 XL	30,0	762,00	150	3,90	4,10	4,80	5,90	8,70	11,40	11,40
310 XL	31,0	787,40	155	3,90	4,10	4,80	5,90	8,70	11,40	11,40
314 XL	31,4	797,56	157	3,90	4,10	4,80	5,90	8,70	11,40	11,40
316 XL	31,6	802,64	158	3,90	4,30	5,10	5,90	8,80	11,60	11,60
320 XL	32,0	812,80	160	3,90	4,30	5,10	5,90	8,80	11,60	11,60
322 XL	32,2	817,88	161	3,90	4,30	5,10	5,90	8,80	11,60	11,60
330 XL	33,0	838,20	165	3,90	4,30	5,10	5,90	8,80	11,60	11,60
340 XL	34,0	863,60	170	4,30	4,80	5,60	7,10	9,80	12,90	12,90
344 XL	34,4	873,76	172	4,30	4,80	5,60	7,10	9,80	12,90	12,90
348 XL	34,8	883,92	174	4,30	4,80	5,60	7,10	9,80	12,90	12,90
352 XL	35,2	894,08	176	4,30	4,80	5,60	7,10	9,80	12,90	12,90
356 XL	35,6	904,24	178	4,30	4,80	5,60	7,10	9,80	12,90	12,90
360 XL	36,0	914,40	180	4,30	4,80	5,60	7,10	9,80	12,90	12,90
364 XL	36,4	924,56	182	4,30	4,80	5,60	7,10	9,80	12,90	12,90
370 XL	37,0	939,80	185	4,30	4,80	5,60	7,10	9,80	12,90	12,90
372 XL	37,2	944,88	186	4,30	4,80	5,60	7,10	9,80	12,90	12,90
376 XL	37,6	955,04	188	4,30	4,80	5,60	7,10	9,80	12,90	12,90
380 XL	38,0	965,20	190	4,30	4,80	5,60	7,10	9,80	12,90	12,90
384 XL	38,4	975,36	192	4,30	4,80	5,60	7,10	9,80	12,90	12,90
386 XL	38,6	980,44	193	4,30	4,80	5,60	7,10	9,80	12,90	12,90
388 XL	38,8	985,52	194	4,30	4,80	5,60	7,10	9,80	12,90	12,90
390 XL	39,0	990,60	195	4,30	4,80	5,60	7,10	9,80	12,90	12,90
392 XL	39,2	995,68	196	4,80	5,40	6,40	8,20	11,40	14,60	14,60
396 XL	39,6	1005,84	198	5,20	5,70	6,90	8,20	12,20	15,50	15,50
400 XL	40,0	1016,00	200	5,20	5,70	6,90	8,20	12,20	15,50	15,50
408 XL	40,8	1036,32	204	5,20	5,70	6,90	8,20	12,20	15,50	15,50
414 XL	41,4	1051,56	207	5,20	5,70	6,90	8,20	12,20	15,50	15,50
424 XL	42,4	1076,96	212	5,90	6,50	7,80	9,40	13,80	17,70	17,70
430 XL	43,0	1092,20	215	5,90	6,50	7,80	9,40	13,80	17,70	17,70
434 XL	43,4	1102,36	217	5,90	6,50	7,80	9,40	13,80	17,70	17,70
450 XL	45,0	1143,00	225	5,90	6,50	7,80	9,40	13,80	17,70	17,70
456 XL	45,6	1158,24	228	5,90	6,50	7,80	9,40	13,80	17,70	17,70
460 XL	46,0	1168,40	230	5,90	6,50	7,80	9,40	13,80	17,70	17,70
470 XL	47,0	1193,80	235	6,60	7,50	8,80	10,50	15,70	20,30	20,30
480 XL	48,0	1219,20	240	6,60	7,50	8,80	10,50	15,70	20,30	20,30
490 XL	49,0	1244,60	245	6,60	7,50	8,80	10,50	15,70	20,30	20,30
496 XL	49,6	1259,84	248	6,60	7,50	8,80	10,50	15,70	20,30	20,30
510 XL	51,0	1295,40	255	6,60	7,50	8,80	10,50	15,70	20,30	20,30
530 XL	53,0	1346,20	265	7,50	8,40	9,90	11,70	17,70	22,80	22,80
540 XL	54,0	1371,60	270	7,50	8,40	9,90	11,70	17,70	22,80	22,80
552 XL	55,2	1402,08	276	7,50	8,40	9,90	11,70	17,70	22,80	22,80
564 XL	56,4	1432,56	282	7,50	8,40	9,90	11,70	17,70	22,80	22,80
592 XL	59,2	1503,68	296	8,20	9,20	10,80	12,90	19,20	24,80	24,80
600 XL	60,0	1524,00	300	8,20	9,20	10,80	12,90	19,20	24,80	24,80
608 XL	60,8	1544,32	304	8,20	9,20	10,80	12,90	19,20	24,80	24,80
630 XL	63,0	1600,20	315	8,20	9,20	10,80	12,90	19,20	24,80	24,80
638 XL	63,8	1620,52	319	10,80	12,00	14,20	17,60	25,20	32,40	32,40
670 XL	67,0	1701,80	335	10,80	12,00	14,20	17,60	25,20	32,40	32,40
686 XL	68,6	1742,44	343	10,80	12,00	14,20	17,60	25,20	32,40	32,40
710 XL	71,0	1803,40	355	10,80	12,00	14,20	17,60	25,20	32,40	32,40
754 XL	75,4	1915,16	377	10,80	12,00	14,20	17,60	25,20	32,40	32,40

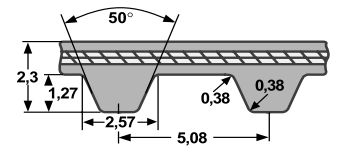

**Type XL - Teilung/ Pitch 5,08 mm**

			Zoll/ Inch mm	Breite/width 1/4	Breite/width 5/16	Breite/width 3/8	Breite/width 1/2	Breite/width 3/4	Breite/width 1
			Zoll/ Inch	6,35	7,94	9,53	12,7	19,05	25,4
			Zähne teeth	025	031	037	050	075	100
	Wirklänge pitch length		Zähne teeth	Stück piece Euro	Stück piece Euro	Stück piece Euro	Stück piece Euro	Stück piece Euro	Stück piece Euro
	Zoll/ inch	mm							
828 XL	82,8	2103,12	414	10,80	12,00	14,20	17,60	25,20	32,40
860 XL	86,0	2184,40	430	11,20	12,40	15,60	18,80	27,60	33,60
888 XL	88,8	2255,52	444	11,20	12,40	15,60	18,50	27,60	33,60
900 XL	90,0	2286,00	450	11,20	12,40	15,60	18,50	27,60	33,60
908 XL	90,8	2306,32	454	11,20	12,40	15,60	18,50	27,60	33,60
914 XL	91,4	2321,56	457	12,60	13,90	17,60	20,80	31,10	37,80
926 XL	92,6	2352,04	463	12,60	13,90	17,60	20,80	31,10	37,80
1014 XL	101,4	2575,56	507	12,60	13,90	17,60	20,80	31,10	37,80
1020 XL	102,0	2590,80	510	12,60	13,90	17,60	20,80	31,10	37,80

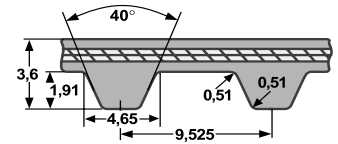

**Type L - Teilung/ Pitch 9,525 mm**

			Zoll/ inch mm	Breite/width 1/2	Breite/width 3/4	Breite/width 1	Breite/width 1 1/2	Breite/width 2	Breite/width 3
			Zoll/ inch	12,7	19,05	25,4	38,1	50,8	76,2
			Zähne teeth	050	075	100	150	200	300
	Wirklänge pitch length		Zähne teeth	Stück piece Euro	Stück piece Euro	Stück piece Euro	Stück piece Euro	Stück piece Euro	Stück piece Euro
	Zoll/ inch	mm							
98 L	9,8	247,65	26	5,30	7,40	9,50	14,30	19,00	28,40
109 L	10,9	276,22	29	5,30	7,40	9,50	14,30	19,00	28,40
124 L	12,4	314,40	33	5,30	7,40	9,50	14,30	19,00	28,40
135 L	13,5	342,90	36	5,90	8,20	10,70	15,70	21,00	31,50
150 L	15,0	381,00	40	5,90	8,20	10,70	15,70	21,00	31,50
165 L	16,5	419,10	44	6,60	9,30	11,70	17,50	23,40	35,00
169 L	16,9	428,63	45	6,60	9,30	11,70	17,50	23,40	35,00
172 L	17,3	438,15	46	6,60	9,30	11,70	17,50	23,40	35,00
187 L	18,8	476,00	50	6,60	9,30	11,70	17,50	23,40	35,00
203 L	20,3	514,35	54	7,10	9,90	12,70	19,10	25,30	38,10
210 L	21,0	533,40	56	7,10	9,90	12,70	19,10	25,30	38,10
218 L	21,8	553,72	58	7,30	10,20	13,00	19,60	26,20	39,20
225 L	22,5	571,50	60	7,30	10,20	13,00	19,60	26,20	39,20
232 L	23,2	589,28	62	7,70	10,90	13,80	20,80	27,50	41,60
240 L	24,0	609,60	64	7,70	10,90	13,80	20,80	27,50	41,60
248 L	24,8	629,92	66	8,00	11,10	14,20	21,30	28,40	42,70
255 L	25,5	647,70	68	8,00	11,10	14,20	21,30	28,40	42,70
263 L	26,3	666,75	70	8,20	11,50	15,00	22,40	30,10	45,40
265 L	26,5	676,27	71	8,20	11,50	15,00	22,40	30,10	45,40
270 L	27,0	685,80	72	8,20	11,50	15,00	22,40	30,10	45,40
277 L	27,8	704,85	74	8,30	11,90	15,50	23,20	31,00	46,20
285 L	28,5	723,90	76	8,30	11,90	15,50	23,20	31,00	46,20
300 L	30,0	762,00	80	9,00	12,30	16,00	24,00	32,10	48,10
304 L	30,4	771,53	81	9,30	12,90	16,90	25,30	33,90	50,60
315 L	31,5	800,10	84	9,30	12,90	16,90	25,30	33,90	50,60
320 L	31,9	809,63	85	9,30	12,90	16,90	25,30	33,90	50,60
322 L	32,3	819,10	86	9,30	12,90	16,90	25,30	33,90	50,60
334 L	33,4	847,73	89	9,60	13,60	17,50	26,30	35,00	52,50
337 L	33,8	857,25	90	9,60	13,60	17,50	26,30	35,00	52,50
345 L	34,5	876,30	92	9,60	13,60	17,50	26,30	35,00	52,50
360 L	36,0	914,40	96	10,50	14,00	18,10	27,40	36,50	54,50
367 L	36,7	933,45	98	10,50	14,00	18,10	27,40	36,50	54,50
375 L	37,5	952,50	100	11,10	15,00	19,30	29,20	38,80	58,30
382 L	38,2	971,55	102	11,10	15,00	19,30	29,20	38,80	58,30
390 L	39,0	990,60	104	11,10	15,00	19,30	29,20	38,80	58,30
394 L	39,4	1000,76	105	11,10	15,60	20,50	30,60	40,90	61,10
398 L	39,8	1010,92	106	11,10	15,60	20,50	30,60	40,90	61,10

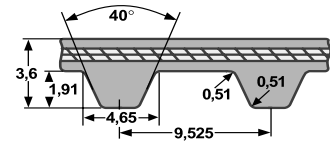

**Type L - Teilung/ Pitch 9,525 mm**

			Zoll/ inch mm	Zoll/ inch	Breite/width 1/2 12,7	Breite/width 3/4 19,05	Breite/width 1 25,4	Breite/width 1 1/2 38,1	Breite/width 2 50,8	Breite/width 3 76,2
			Zähne teeth	Stück piece Euro	Stück piece Euro	Stück piece Euro	Stück piece Euro	Stück piece Euro	Stück piece Euro	Stück piece Euro
	Wirklänge pitch length									
	Zoll/ inch	mm								
405 L	40,5	1028,70	108	11,10	15,60	20,50	30,60	40,90	61,10	61,10
420 L	42,0	1066,80	112	11,10	15,60	20,50	30,60	40,90	61,10	61,10
427 L	42,7	1084,58	114	11,50	16,70	21,70	32,30	43,40	64,30	64,30
436 L	43,6	1104,90	116	11,50	16,70	21,70	32,30	43,40	64,30	64,30
439 L	43,9	1114,43	117	11,50	16,70	21,70	32,30	43,40	64,30	64,30
446 L	44,6	1133,48	119	11,50	16,70	21,70	32,30	43,40	64,30	64,30
450 L	45,0	1143,00	120	11,50	16,70	21,70	32,30	43,40	64,30	64,30
454 L	45,4	1153,16	121	12,20	17,50	22,70	33,90	45,40	67,80	67,80
465 L	46,5	1181,10	124	12,20	17,50	22,70	33,90	45,40	67,80	67,80
480 L	48,0	1219,20	128	12,20	17,50	22,70	33,90	45,40	67,80	67,80
510 L	51,0	1295,40	136	12,30	17,90	23,40	33,90	46,80	70,00	70,00
514 L	51,4	1304,93	137	13,40	19,00	25,00	35,20	49,70	74,60	74,60
525 L	52,5	1333,50	140	13,40	19,00	25,00	35,20	49,70	74,60	74,60
540 L	54,0	1371,60	144	13,40	19,00	25,00	35,20	49,70	74,60	74,60
548 L	54,8	1390,65	146	14,30	20,80	27,00	38,40	54,10	81,10	81,10
581 L	58,1	1476,38	155	14,30	20,80	27,00	40,70	54,10	81,10	81,10
600 L	60,0	1524,00	160	14,30	20,80	27,00	40,70	54,10	81,10	81,10
605 L	60,5	1533,53	161	16,90	24,70	32,10	40,70	63,90	96,30	96,30
619 L	61,9	1571,63	165	16,90	24,70	32,10	48,10	63,90	96,30	96,30
630 L	63,0	1600,20	168	16,90	24,70	32,10	48,10	63,90	96,30	96,30
640 L	64,0	1619,25	170	16,90	24,70	32,10	48,10	63,90	96,30	96,30
653 L	65,3	1657,35	174	16,90	24,70	32,10	48,10	63,90	96,30	96,30
660 L	66,0	1676,40	176	16,90	24,70	32,10	48,10	63,90	96,30	96,30
697 L	69,7	1771,65	186	20,30	29,50	39,00	48,10	76,60	115,70	115,70
728 L	72,8	1847,85	194	20,30	29,50	39,00	57,60	76,60	115,70	115,70
731 L	73,1	1857,38	195	20,30	29,50	39,00	57,60	76,60	115,70	115,70
767 L	76,7	1952,63	205	20,30	29,50	39,00	57,60	76,60	115,70	115,70
780 L	78,0	1981,20	208	20,30	29,50	39,00	57,60	76,60	115,70	115,70
788 L	78,8	2000,25	210	20,30	29,50	39,00	57,60	76,60	115,70	115,70
806 L	80,6	2047,88	215	23,50	34,40	45,50	67,10	89,00	134,60	134,60
817 L	81,7	2075,18	218	23,50	34,40	45,50	67,10	89,00	134,60	134,60
855 L	85,5	2171,70	228	23,50	34,40	45,50	67,10	89,00	134,60	134,60
863 L	86,3	2190,75	230	23,50	34,40	45,50	67,10	89,00	134,60	134,60
881 L	88,1	2238,38	235	23,50	34,40	45,50	67,10	89,00	134,60	134,60
915 L	91,5	2324,10	244	23,50	34,40	45,50	67,10	89,00	134,60	134,60
919 L	91,9	2333,63	245	24,00	35,20	46,50	68,80	91,20	138,00	138,00
934 L	93,4	2372,36	249	24,00	35,20	46,50	68,80	91,20	138,00	138,00
938 L	93,8	2381,25	250	24,00	35,20	46,50	68,80	91,20	138,00	138,00
1294 L	129,4	3286,76	345	33,30	48,60	64,20	94,70	125,70	190,50	190,50

Wickelpreise auf Anfrage.

Prices of sleeves on request.

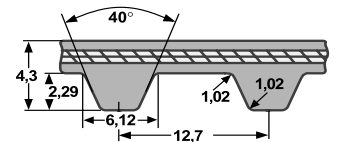

### Type H - Teilung/ Pitch 12,7 mm

			Zoll inch	Breite/width	Breite/width	Breite/width	Breite/width	Breite/width	Breite/width	Breite/width
				¾	1	1 1/2	2	3	4	5
				mm	19,05	25,4	38,1	50,8	76,2	101,6
			Zoll inch	075	100	150	200	300	400	500
	Wirklänge pitch length		Zähne teeth	Stück piece	Stück piece	Stück piece	Stück piece	Stück piece	Stück piece	Stück piece
	Zoll inch	mm								
185 H	18,5	469,9	37	10,90	13,70	20,00	26,30	38,50	54,20	67,80
225 H	22,5	571,5	45	12,00	15,30	22,30	29,10	42,80	60,10	75,30
230 H	23,0	584,2	46	12,00	15,30	22,30	29,10	42,80	60,10	75,30
240 H	24,0	609,6	48	12,00	15,30	22,30	29,10	42,80	60,10	75,30
245 H	24,5	622,3	49	12,90	16,70	24,00	31,60	46,20	66,20	83,10
255 H	25,5	647,7	51	12,90	16,70	24,00	31,60	46,20	66,20	83,10
270 H	27,0	685,8	54	12,90	16,70	24,00	31,60	46,20	66,20	83,10
280 H	28,0	711,2	56	13,80	17,90	26,10	33,90	49,90	71,70	88,50
300 H	30,0	762,0	60	13,80	17,90	26,10	33,90	49,90	71,70	88,50
310 H	31,0	787,4	62	14,60	19,10	27,60	36,50	53,50	75,90	95,10
315 H	31,5	800,1	63	14,60	19,10	27,60	36,50	53,50	75,90	95,10
320 H	32,0	812,8	64	14,60	19,10	27,60	36,50	53,50	75,90	95,10
330 H	33,0	838,2	66	14,60	19,10	27,60	36,50	53,50	75,90	95,10
340 H	34,0	863,6	68	15,50	20,30	29,40	38,80	57,30	81,90	100,60
350 H	35,0	889,0	70	15,50	20,30	29,40	38,80	57,30	81,90	100,60
360 H	36,0	914,4	72	15,50	20,30	29,40	38,80	57,30	81,90	100,60
370 H	37,0	939,8	74	16,60	21,40	31,20	40,60	60,90	86,10	107,20
375 H	37,5	952,5	75	16,60	21,40	31,20	40,60	60,90	86,10	107,20
390 H	39,0	990,6	78	16,60	21,40	31,20	40,60	60,90	86,10	107,20
400 H	40,0	1016,0	80	17,20	22,60	33,20	43,60	64,30	89,80	112,50
410 H	41,0	1041,4	82	17,20	22,60	33,20	43,60	64,30	89,80	112,50
420 H	42,0	1066,8	84	17,20	22,60	33,20	43,60	64,30	89,80	112,50
430 H	43,0	1092,2	86	18,40	23,90	34,90	46,90	68,10	95,10	118,90
450 H	45,0	1143,0	90	18,40	23,90	34,90	46,90	68,10	95,10	118,90
465 H	46,5	1181,1	93	19,20	25,00	36,80	49,20	72,30	99,40	124,80
480 H	48,0	1219,2	96	19,20	25,00	36,80	49,20	72,30	99,40	124,80
490 H	49,0	1244,6	98	19,70	26,20	37,90	50,90	74,10	104,70	130,80
510 H	51,0	1295,4	102	19,70	26,20	37,90	50,90	74,10	104,70	130,80
530 H	53,0	1346,2	106	20,90	27,50	40,30	54,10	78,30	109,70	137,30
540 H	54,0	1371,6	108	20,90	27,50	40,30	54,10	78,30	109,70	137,30
560 H	56,0	1422,4	112	21,80	28,30	41,70	55,60	81,90	112,50	141,60
565 H	56,5	1435,1	113	21,80	28,30	41,70	55,60	81,90	112,50	141,60
570 H	57,0	1447,8	114	21,80	28,30	41,70	55,60	81,90	112,50	141,60
580 H	58,0	1473,2	115	22,40	29,30	43,40	57,50	86,10	118,00	146,90
600 H	60,0	1524,0	120	22,40	29,30	43,40	57,50	86,10	118,00	146,90
605 H	60,5	1536,7	121	22,70	29,50	44,00	58,10	86,70	118,60	148,10
625 H	62,5	1587,5	125	22,70	29,50	44,00	58,10	86,70	118,60	148,10
630 H	63,0	1600,2	126	22,70	29,50	44,00	58,10	86,70	118,60	148,10
640 H	64,0	1625,6	128	23,30	30,50	45,80	60,90	90,90	121,60	151,80
650 H	65,0	1651,0	130	23,30	30,50	45,80	60,90	90,90	121,60	151,80
660 H	66,0	1676,4	132	23,30	30,50	45,80	60,90	90,90	121,60	151,80
680 H	68,0	1727,2	136	24,50	32,10	48,10	63,80	96,30	128,90	160,20
700 H	70,0	1778,0	140	24,50	32,10	48,10	63,80	96,30	134,40	160,20
725 H	72,5	1841,5	145	25,50	33,60	50,40	67,40	100,60	134,40	168,60
730 H	73,0	1854,2	146	25,50	33,60	50,40	67,40	100,60	134,40	168,60
750 H	75,0	1905,0	150	25,50	33,60	50,40	67,40	100,60	134,40	168,60
760 H	76,0	1930,4	152	27,40	35,90	53,90	72,30	107,80	143,90	179,40
770 H	77,0	1955,8	154	27,40	35,90	53,90	72,30	107,80	143,90	179,40
800 H	80,0	2032,0	160	27,40	35,90	53,90	72,30	107,80	143,90	179,40
810 H	81,0	2057,4	162	28,60	37,40	56,00	74,70	111,90	149,30	186,20
820 H	82,0	2082,8	164	28,60	37,40	56,00	74,70	111,90	149,30	186,20
840 H	84,0	2133,6	168	28,60	37,40	56,00	74,70	111,90	149,30	186,20
850 H	85,0	2159,0	170	28,60	37,40	56,00	74,70	111,90	149,30	186,20
860 H	86,0	2184,4	172	30,30	39,80	59,70	78,90	119,30	159,00	198,70
880 H	88,0	2235,2	176	30,30	39,80	59,70	78,90	119,30	159,00	198,70
900 H	90,0	2286,0	180	30,30	39,80	59,70	78,90	119,30	159,00	198,70
950 H	95,0	2413,0	190	33,30	43,40	65,10	86,70	130,80	174,00	217,40
985 H	98,5	2501,9	197	33,30	43,40	65,10	86,70	130,80	174,00	217,40

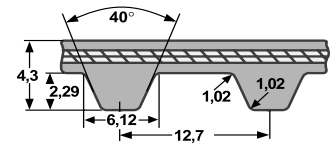

### Type H - Teilung/ Pitch 12,7 mm

		Zoll inch	Breite/width ¾	Breite/width 1	Breite/width 1 1/2	Breite/width 2	Breite/width 3	Breite/width 4	Breite/width 5								
										mm	19,05	25,4	38,1	50,8	76,2	101,6	127
										Zoll inch	075	100	150	200	300	400	500
	Wirklänge pitch length		Zähne teeth	Stück piece	Stück piece	Stück piece	Stück piece	Stück piece	Stück piece								
	Zoll inch	mm								Euro	Euro	Euro	Euro	Euro	Euro		
1000 H	100	2540,0	200	33,30	43,40	65,10	86,70	130,80	174,00	217,40							
1020 H	102	2590,8	204	35,90	47,10	71,10	94,50	141,60	187,90	235,50							
1050 H	105	2667,0	210	35,90	47,10	71,10	94,50	141,60	187,90	235,50							
1100 H	110	2794,0	220	35,90	47,10	71,10	94,50	141,60	187,90	235,50							
1120 H	112	2844,8	224	40,30	53,10	78,90	106,00	159,60	211,90	265,60							
1130 H	113	2870,4	226	40,30	53,10	78,90	106,00	159,60	211,90	265,60							
1140 H	114	2895,6	228	40,30	53,10	78,90	106,00	159,60	211,90	265,60							
1250 H	125	3175,0	250	40,30	53,10	78,90	106,00	159,60	211,90	265,60							
1325 H	132,5	3365,5	265	44,10	58,80	87,90	118,00	175,80	234,90	293,90							
1350 H	135	3429,0	270	44,10	58,80	87,90	118,00	175,80	234,90	293,90							
1360 H	136	3454,4	272	44,10	58,80	87,90	118,00	175,80	234,90	293,90							
1400 H	140	3556,0	280	44,10	58,80	87,90	118,00	175,80	234,90	293,90							
1680 H	168	4267,2	336	53,30	69,80	105,50	140,80	210,10	280,70	351,80							
1700 H	170	4318,0	340	53,30	69,80	105,50	140,80	210,10	280,70	351,80							

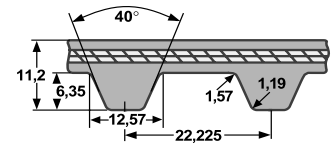

### Type XH - Teilung/ Pitch 22,225 mm

		Zoll inch	Breite/width 2	Breite/width 3	Breite/width 4	Breite/width 5	Breite/width 6	Breite/width 7							
									mm	50,8	76,2	101,6	127,0	152,4	177,8
									Zoll inch	200	300	400	500	600	700
	Wirklänge pitch length		Zähne teeth	Stück piece	Stück piece	Stück piece	Stück piece	Stück piece							
	Zoll inch	mm							Euro	Euro	Euro	Euro	Euro		
507 XH	50,0	1289,0	58	108,30	162,50	217,30	271,00	324,90	379,70						
534 XH	53,4	1356,4	61	115,60	173,40	231,20	288,00	346,30	404,00						
560 XH	56,0	1422,4	64	115,60	173,40	231,20	288,00	346,30	404,00						
630 XH	63,0	1600,2	72	122,40	183,70	244,10	306,10	367,60	428,40						
700 XH	70,0	1778,0	80	132,10	197,10	263,00	329,30	395,00	460,00						
735 XH	73,5	1866,9	84	138,20	208,20	276,90	346,30	415,80	484,40						
770 XH	77,0	1955,8	88	138,20	208,20	276,90	346,30	415,80	484,40						
840 XH	84,0	2133,6	96	147,90	221,50	294,10	369,40	443,00	516,60						
875 XH	87,5	2222,5	100	163,70	247,00	328,70	410,80	492,90	575,70						
927 XH	92,7	2355,9	106	163,70	247,00	328,70	410,80	492,90	575,70						
980 XH	98,0	2489,2	112	163,70	247,00	328,70	410,80	492,90	575,70						
1120 XH	112	2844,8	128	177,80	267,20	356,50	445,40	534,30	623,30						
1260 XH	126	3200,4	144	200,80	300,10	401,00	502,10	601,90	701,60						
1400 XH	140	3556,0	160	219,10	328,00	437,00	546,50	656,00	765,40						
1540 XH	154	3911,6	176	231,20	345,60	460,60	576,90	691,90	806,30						
1750 XH	175	4445,0	200	260,40	390,80	520,80	651,10	781,30	910,90						

Wickelpreise auf Anfrage.

Prices of sleeves on request.

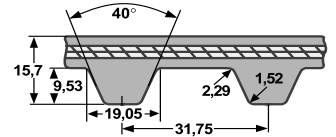

## Type XXH - Teilung/ Pitch 31,75 mm

			Zoll inch	Breite/width		Breite/width		Breite/width		Breite/width	
				2		3		4		5	
				mm		mm		mm		mm	
			Zoll inch	200		300		400		500	
			Zoll inch	200		300		400		500	
			Zoll inch	200		300		400		500	
			Zoll inch	200		300		400		500	
	Wirklänge pitch length		Zähne teeth	Stück piece	Stück piece	Stück piece	Stück piece	Stück piece	Stück piece	Stück piece	
	Zoll inch	mm									
700 XXH	70	1778,0	56	270,10	418,00	558,20	734,40				
800 XXH	80	2032,0	64	301,90	466,20	622,70	816,90				
900 XXH	90	2286,0	72	333,50	514,50	686,80	899,40				
1000 XXH	100	2540,0	80	364,50	563,50	751,50	982,00				
1200 XXH	120	3048,0	96	431,80	665,10	888,20	1121,40				
1400 XXH	140	3556,0	112	493,30	750,80	999,80	1248,70				
1600 XXH	160	4064,0	128	567,40	869,80	1130,60	1432,40				
1800 XXH	180	4572,0	144	631,20	969,30	1242,10	1567,10				
1915 XXH	191,5	4857,8	153	633,10	1030,00	1319,80	1665,10				

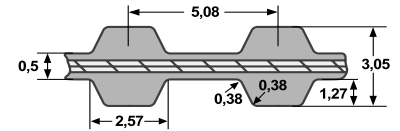

## Type DXL - Teilung/ Pitch 5,08 mm doppelt gezahnt/ double toothed

			Zoll inch	Breite/width		Breite/width		Breite/width	
				¼		5/16		3/8	
				mm		mm		mm	
			Zoll inch	025		031		037	
			Zoll inch	025		031		037	
			Zoll inch	025		031		037	
			Zoll inch	025		031		037	
	Wirklänge pitch length		Zähne teeth	Stück piece	Stück piece	Stück piece	Stück piece	Stück piece	Stück piece
	Zoll inch	mm							
120 DXL	12,0	304,80	60	7,10	11,70	13,50			
130 DXL	13,0	330,20	65	7,50	11,70	13,50			
140 DXL	14,0	355,60	70	8,10	11,70	13,50			
150 DXL	15,0	381,00	75	8,50	11,70	13,50			
156 DXL	15,6	196,24	78	10,70	11,70	13,50			
160 DXL	16,0	406,40	80	10,70	11,70	13,50			
162 DXL	16,2	411,48	81	10,90	12,00	13,70			
164 DXL	16,4	416,66	82	10,90	12,00	13,70			
166 DXL	16,6	421,64	83	10,90	12,00	13,70			
168 DXL	16,8	426,72	84	10,90	12,00	13,70			
170 DXL	17,0	431,80	85	10,90	12,00	13,70			
172 DXL	17,2	436,88	86	11,10	12,70	13,80			
174 DXL	17,4	441,96	87	11,10	12,70	13,80			
176 DXL	17,6	447,04	88	11,10	12,70	13,80			
178 DXL	17,8	452,12	89	11,10	12,70	13,80			
180 DXL	18,0	457,20	90	11,10	12,70	13,80			
182 DXL	18,2	462,28	91	11,30	12,80	14,40			
184 DXL	18,4	467,36	92	11,30	12,80	14,40			
188 DXL	18,8	477,52	94	11,30	12,80	14,40			
190 DXL	19,0	482,60	95	11,30	12,80	14,40			
194 DXL	19,4	492,78	97	11,60	13,00	14,90			
196 DXL	19,6	497,84	98	11,60	13,00	14,90			
198 DXL	19,8	502,92	99	11,60	13,00	14,90			
200 DXL	20,0	508,00	100	11,60	13,00	14,90			
202 DXL	20,2	513,08	101	11,70	13,20	15,00			
206 DXL	20,6	523,24	103	11,70	13,20	15,00			
208 DXL	20,8	528,32	104	11,70	13,20	15,00			
210 DXL	21,0	533,40	105	11,70	13,20	15,00			
212 DXL	21,2	538,48	106	12,00	13,50	15,50			
214 DXL	21,4	543,56	107	12,00	13,50	15,50			
216 DXL	21,6	548,64	108	12,00	13,50	15,50			

## Neoprene - Zahnflachriemen - doppelt gezahnt Neoprene - Timing Belts - double toothed

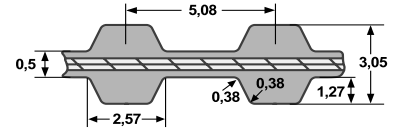

### Type DXL - Teilung/ Pitch 5,08 mm

	Wirklänge pitch length		Zoll/ inch mm Zoll/ inch	Zähne teeth	Breite/width		Breite/width		Breite/width	
					1/4	5/16	3/8	3/8	5/16	1/4
	Zoll/ inch	mm			Stück piece Euro	Stück piece Euro	Stück piece Euro	Stück piece Euro	Stück piece Euro	Stück piece Euro
220 DXL	22,0	558,80	110	12,00	13,50	15,50				
222 DXL	22,2	563,88	111	12,70	13,70	15,60				
224 DXL	22,4	568,96	112	12,70	13,70	15,60				
228 DXL	22,8	579,12	114	12,70	13,70	15,60				
230 DXL	23,0	584,20	115	12,70	13,70	15,60				
234 DXL	23,4	594,36	117	13,00	14,40	16,50				
240 DXL	24,0	609,60	120	13,00	14,40	16,50				
244 DXL	24,4	619,76	122	13,00	14,40	16,50				
248 DXL	24,8	629,92	124	13,00	14,40	16,50				
250 DXL	25,0	635,00	125	13,00	14,40	16,50				
260 DXL	26,0	660,40	130	13,20	14,60	16,90				
262 DXL	26,2	665,48	131	13,50	15,00	17,20				
266 DXL	26,6	675,64	133	13,50	15,00	17,20				
270 DXL	27,0	685,80	135	13,50	15,00	17,20				
276 DXL	27,6	701,04	139	13,70	15,30	17,50				
280 DXL	28,0	711,20	140	13,70	15,30	17,50				
282 DXL	28,2	716,28	141	13,80	15,50	17,70				
290 DXL	29,0	736,60	145	13,80	15,50	17,70				
300 DXL	30,0	762,00	150	14,40	15,60	18,10				
310 DXL	31,0	787,40	155	16,00	17,60	20,30				
314 DXL	31,4	797,56	157	16,30	17,80	20,60				
316 DXL	31,6	802,64	158	16,30	17,90	20,70				
320 DXL	32,0	812,80	160	16,60	18,00	20,90				
322 DXL	32,2	817,88	161	16,70	18,10	21,00				
330 DXL	33,0	838,20	165	17,00	18,70	21,70				
340 DXL	34,0	863,60	170	17,60	19,20	22,30				
344 DXL	34,4	873,76	172	17,80	19,50	22,60				
348 DXL	34,8	883,92	174	18,00	19,70	22,80				
352 DXL	35,2	894,24	176	18,10	19,90	23,10				
356 DXL	35,6	904,24	178	18,50	20,00	23,30				
360 DXL	36,0	914,40	180	18,70	20,50	23,50				
364 DXL	36,4	924,56	182	18,90	20,70	23,80				
370 DXL	37,0	939,80	185	19,10	21,00	24,20				
372 DXL	37,2	944,88	186	19,20	21,00	24,30				
376 DXL	37,6	955,04	188	19,50	21,20	24,70				
380 DXL	38,0	965,20	190	19,60	21,40	24,90				
384 DXL	38,4	975,36	192	19,80	21,80	25,10				
386 DXL	38,6	980,44	193	19,80	21,80	25,10				
388 DXL	38,8	985,52	194	20,00	22,00	25,30				
390 DXL	39,0	990,60	195	20,00	22,00	24,30				
392 DXL	39,2	995,68	196	20,30	22,20	25,50				
396 DXL	39,6	1005,84	198	20,60	22,40	25,90				
400 DXL	40,0	1016,00	200	20,70	22,70	26,20				
408 DXL	40,8	1036,32	204	21,10	23,20	26,60				
424 DXL	42,4	1076,96	212	21,90	24,00	27,70				
430 DXL	43,0	1092,29	215	22,30	24,30	28,10				
434 DXL	43,4	1102,36	217	22,40	24,70	28,40				
450 DXL	45,0	1143,00	225	23,30	25,40	29,40				
456 DXL	45,6	1158,24	228	23,50	25,60	29,70				
460 DXL	46,0	1168,40	230	23,80	26,10	30,20				
470 DXL	47,0	1193,80	235	24,30	26,60	30,70				
490 DXL	49,0	1244,60	245	25,30	27,70	32,10				
496 DXL	49,6	1259,84	248	25,50	28,10	32,40				
510 DXL	51,0	1295,40	255	26,40	29,00	33,30				
530 DXL	53,0	1346,20	265	27,40	30,10	34,70				
540 DXL	54,0	1371,60	270	27,90	30,60	35,30				
564 DXL	56,4	1432,56	282	29,20	31,90	36,80				
592 DXL	59,2	1503,68	296	30,60	33,50	38,70				
600 DXL	60,0	1524,00	300	31,10	33,90	39,10				
608 DXL	60,8	1544,32	304	31,50	34,50	39,80				
630 DXL	63,0	1600,20	315	32,50	35,80	41,10				

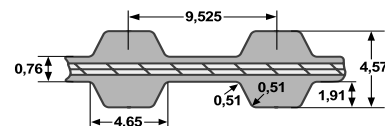

### Type DL - Teilung/ Pitch 9,525 mm

	Zoll/ inch mm		Zoll/ inch	Breite/width		Breite/width		Breite/width	
				1/2	3/4	1	1/2	3/4	1
	Wirklänge pitch length		Zähne teeth	Stück piece	Stück piece	Stück piece	Euro	Euro	Euro
	Zoll/ inch	mm		Euro	Euro	Euro			
124 DL	12,4	314,96	33	24,80	34,40	43,80			
135 DL	13,5	342,90	36	24,80	34,40	43,80			
150 DL	15,0	381,00	40	24,80	34,40	43,80			
165 DL	16,5	419,10	44	24,80	34,40	43,80			
169 DL	16,9	428,63	45	24,80	34,40	43,80			
172 DL	17,2	438,15	46	24,80	34,40	43,80			
173 DL	17,3	439,42	43	24,80	34,40	43,80			
187 DL	18,7	476,20	50	24,80	34,40	43,80			
202 DL	20,2	513,08	54	26,60	37,30	47,80			
203 DL	20,3	514,35	54	26,60	37,30	47,80			
210 DL	21,0	533,40	56	26,60	37,30	47,80			
218 DL	21,8	553,72	58	27,00	38,10	49,00			
225 DL	22,5	571,50	60	27,00	38,10	49,00			
240 DL	24,0	609,60	64	29,00	40,60	52,00			
248 DL	24,8	629,92	66	29,70	41,20	53,30			
255 DL	25,5	647,70	68	29,70	41,20	53,30			
263 DL	26,3	666,75	70	30,80	43,20	55,80			
265 DL	26,5	673,10	71	30,80	43,20	55,80			
270 DL	27,0	685,80	72	30,80	43,20	55,80			
277 DL	27,7	704,85	74	31,20	44,60	57,70			
285 DL	28,5	723,90	76	31,20	44,60	57,70			
300 DL	30,0	762,00	80	33,50	45,90	60,00			
304 DL	30,4	771,53	81	34,40	48,20	63,50			
315 DL	31,5	800,10	84	34,40	48,20	63,50			
320 DL	32,0	809,63	85	34,40	48,20	63,50			
322 DL	32,2	819,10	86	34,40	48,20	63,50			
334 DL	33,4	847,73	89	35,90	50,90	65,30			
337 DL	33,7	857,25	90	35,90	50,90	65,30			
345 DL	34,5	876,30	92	35,90	50,90	65,30			
360 DL	36,0	914,40	96	37,10	52,50	68,00			
367 DL	36,7	933,40	98	37,10	52,50	68,00			
375 DL	37,5	952,50	100	38,80	55,70	72,50			
382 DL	38,2	971,55	102	38,80	55,70	72,50			
390 DL	39,0	990,60	104	38,80	55,70	72,50			
394 DL	39,4	1000,76	105	41,20	58,60	76,30			
405 DL	40,5	1028,70	108	41,20	58,60	76,30			
412 DL	41,2	1046,48	110	41,20	58,60	76,30			
420 DL	42,0	1066,80	112	41,20	58,60	76,30			
427 DL	42,7	1085,85	114	43,20	62,20	80,70			
436 DL	43,6	1107,44	116	43,20	62,20	80,70			
439 DL	43,9	1114,43	117	43,20	62,20	80,70			
446 DL	44,6	1133,48	119	43,20	62,20	80,70			
450 DL	45,0	1143,00	120	43,20	62,20	80,70			
465 DL	46,5	1181,10	124	45,50	65,00	85,00			
480 DL	48,0	1219,20	128	45,50	65,00	85,00			
510 DL	51,0	1295,40	136	45,90	67,20	87,40			
514 DL	51,4	1304,93	137	49,70	70,60	93,20			
525 DL	52,5	1333,50	140	49,70	70,60	93,20			
540 DL	54,0	1371,60	144	49,70	70,60	93,20			
548 DL	54,8	1390,65	146	53,80	77,20	101,40			
581 DL	58,1	1476,38	155	53,80	77,20	101,40			
600 DL	60,0	1524,00	160	53,80	77,20	101,40			
605 DL	60,5	1533,53	161	57,90	84,00	109,60			
619 DL	61,9	1571,63	165	57,90	84,00	109,60			
630 DL	63,0	1600,20	168	57,90	84,00	109,60			
640 DL	64,0	1619,25	170	60,90	88,00	115,20			
653 DL	65,3	1657,35	174	60,90	88,00	115,20			
660 DL	66,0	1676,40	176	60,90	88,00	115,20			
697 DL	69,7	1771,65	186	67,30	97,50	127,60			
728 DL	72,8	1847,85	194	67,30	97,50	127,60			
731 DL	73,1	1857,38	195	67,30	97,50	127,60			

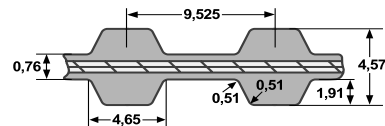

### Type DL - Teilung/ Pitch 9,525 mm

	Wirklänge pitch length		Zähne teeth	Breite/width		Breite/width		Breite/width	
				Zoll/ inch	mm	1/2	3/4	1	Zoll/ inch
	Zoll/ inch	mm		Stück piece	Euro	Stück piece	Euro	Stück piece	Euro
767 DL	76,7	1952,63	205	72,60		105,00		137,30	
780 DL	78,0	1981,20	208	72,60		105,00		137,30	
788 DL	78,8	2000,25	210	72,60		105,00		137,30	
806 DL	80,6	2047,88	215	78,80		114,00		149,00	
817 DL	81,7	2075,18	218	78,80		114,00		149,00	
855 DL	85,5	2171,70	228	78,80		114,00		149,00	
863 DL	86,3	2190,75	230	84,50		121,90		150,50	
881 DL	88,1	2238,38	235	84,50		121,90		150,50	
915 DL	91,5	2324,10	244	84,50		121,90		150,50	
919 DL	91,9	2333,63	245	86,40		125,00		163,50	
938 DL	93,8	2381,25	250	86,40		125,00		163,50	
1294 DL	129,4	3286,76	345	119,30		172,50		225,60	

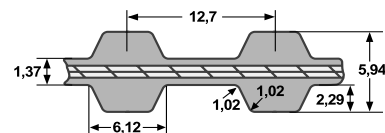

### Type DH - Teilung/ Pitch 12,7 mm

	Wirklänge pitch length		Zähne teeth	Breite/width		Breite/width		Breite/width		Breite/width	
				Zoll/ inch	mm	3/4	1	1 1/2	2	3	Zoll/ inch
	Zoll/ inch	mm		Stück piece	Euro	Stück piece	Euro	Stück piece	Euro	Stück piece	Euro
185 DH	18,5	469,90	37	42,60		53,50		78,60		102,80	
225 DH	22,5	571,50	45	42,60		53,50		78,60		102,80	
230 DH	23,0	584,20	46	42,60		53,50		78,60		102,80	
240 DH	24,0	609,60	48	42,60		53,50		78,60		102,80	
245 DH	24,5	622,30	49	45,70		58,60		84,90		111,50	
270 DH	27,0	685,80	54	45,70		58,60		84,90		111,50	
280 DH	28,0	711,20	56	48,60		64,20		91,20		119,60	
300 DH	30,0	762,00	60	48,60		64,20		91,20		119,60	
310 DH	31,0	787,40	62	51,60		67,40		97,70		128,50	
315 DH	31,5	800,10	63	51,60		67,40		97,70		128,50	
320 DH	32,0	812,80	64	51,60		67,40		97,70		128,50	
330 DH	33,0	838,20	66	51,60		67,40		97,70		128,50	
340 DH	34,0	863,60	68	54,70		71,30		104,40		136,70	
350 DH	35,0	889,00	70	54,70		71,30		104,40		136,70	
360 DH	36,0	914,40	72	54,70		71,30		104,40		136,70	
370 DH	37,0	939,80	74	58,10		76,20		110,00		143,20	
375 DH	37,5	952,50	75	58,10		76,20		110,00		143,20	
390 DH	39,0	990,60	78	58,10		76,20		110,00		143,20	
400 DH	40,0	1016,00	80	61,10		79,40		117,00		153,50	
410 DH	41,0	1041,40	82	61,10		79,40		117,00		153,50	
420 DH	42,0	1066,80	84	61,10		79,40		117,00		153,50	
430 DH	43,0	1092,20	86	64,90		84,50		123,30		165,20	
450 DH	45,0	1143,00	90	64,90		84,50		123,30		165,20	
465 DH	46,5	1181,10	93	67,80		88,00		129,70		173,70	
480 DH	48,0	1219,20	96	67,80		88,00		129,70		173,70	
490 DH	49,0	1244,60	98	69,60		92,00		133,80		179,40	
510 DH	51,0	1295,40	102	69,60		92,00		133,80		179,40	
530 DH	53,0	1346,20	106	73,80		97,40		142,20		190,50	
540 DH	54,0	1371,60	108	73,80		97,40		142,20		190,50	
560 DH	56,0	1422,40	112	76,70		99,70		146,70		195,90	
565 DH	56,5	1435,10	113	76,70		99,70		146,70		195,90	
570 DH	57,0	1447,80	114	76,70		99,70		146,70		195,90	
580 DH	58,0	1473,20	116	79,00		103,40		153,30		203,00	
600 DH	60,0	1524,00	120	79,00		103,40		153,30		203,00	

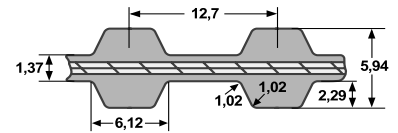

**Type DH - Teilung/ Pitch 12,7 mm**

	Wirklänge pitch length		Zähne teeth	Breite/width				
				Stück piece Euro	Stück piece Euro	Stück piece Euro	Stück piece Euro	Stück piece Euro
	Zoll/ inch	mm	Zoll/ inch	$\frac{3}{4}$ 19,05 075	1 25,4 100	1 1/2 38,1 150	2 50,8 200	3 76,2 300
	Zoll/ inch	mm	Zoll/ inch	Stück piece Euro	Stück piece Euro	Stück piece Euro	Stück piece Euro	Stück piece Euro
605 DH	60,5	1536,70	121	79,80	104,20	155,30	205,30	305,90
625 DH	62,5	1587,50	125	79,80	104,20	155,30	205,30	305,90
630 DH	63,0	1600,20	126	79,80	104,20	155,30	205,30	305,90
640 DH	64,0	1625,60	128	82,40	107,50	161,20	214,50	320,70
650 DH	65,0	1651,00	130	82,40	107,50	161,20	214,50	320,70
660 DH	66,0	1676,40	132	82,40	107,50	161,20	214,50	320,70
680 DH	68,0	1727,20	136	86,30	112,90	169,40	225,20	339,70
700 DH	70,0	1778,00	140	86,30	112,90	169,40	225,20	339,70
730 DH	73,0	1854,20	146	90,30	118,90	177,80	237,90	354,60
750 DH	75,0	1905,00	150	90,30	118,90	177,80	237,90	354,60
760 DH	76,0	1930,40	152	96,50	126,50	190,10	254,80	380,10
770 DH	77,0	1955,80	154	96,50	126,50	190,10	254,80	380,10
800 DH	80,0	2032,00	160	96,50	126,50	190,10	254,80	380,10
810 DH	81,0	2057,40	162	100,40	132,00	197,80	263,30	395,00
820 DH	82,0	2082,80	164	100,40	132,00	197,80	263,30	395,00
840 DH	84,0	2133,60	168	100,40	132,00	197,80	263,30	395,00
850 DH	85,0	2159,00	170	100,40	132,00	197,80	263,30	395,00
860 DH	86,0	2184,40	172	106,80	140,20	210,40	278,10	420,40
880 DH	88,0	2235,20	176	106,80	140,20	210,40	278,10	420,40
900 DH	90,0	2286,00	180	106,80	140,20	210,40	278,10	420,40
950 DH	95,0	2413,00	190	117,30	153,30	229,40	305,90	460,80
985 DH	98,5	2501,90	197	117,30	153,30	229,40	305,90	460,80
1000 DH	100,0	2540,00	200	117,30	166,20	229,40	305,90	460,80
1020 DH	102,0	2590,80	204	126,50	166,20	250,50	333,30	499,10
1050 DH	105,0	2667,00	210	126,50	166,20	250,50	333,30	499,10
1100 DH	110,0	2794,00	220	126,50	166,20	250,50	333,30	499,10
1130 DH	113,0	2870,20	226	142,20	187,00	278,10	373,60	562,70
1140 DH	114,0	2895,60	228	142,20	187,00	278,10	373,60	562,70
1250 DH	125,0	3175,00	250	142,20	187,00	278,10	373,60	562,70
1325 DH	132,5	3175,00	250	142,20	187,00	278,10	373,60	562,70
1350 DH	135,0	3429,00	270	155,10	207,20	310,10	416,20	620,10
1400 DH	140,0	3556,00	280	155,10	207,20	310,10	416,20	620,10
1680 DH	168,0	4267,20	336	188,00	246,40	371,70	496,90	741,10
1700 DH	170,0	4318,00	340	188,00	246,40	371,70	496,90	741,10
Wickelpreise auf Anfrage. Prices of sleeves on request.								

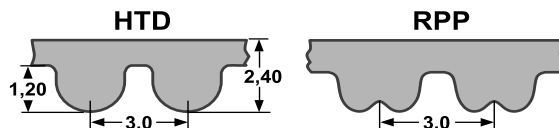

### Type 3M - Teilung/ Pitch 3 mm

Größe size	Wirklänge pitch length mm	Zähnezahl number of teeth	Breite width	Breite width	Breite width
			6 mm	9 mm	15 mm
			Stück/ piece Euro	Stück/ piece Euro	Stück/ piece Euro
<b>90-3M</b>	90	30	2,70	3,50	5,50
105-3M	105	35	2,80	3,60	5,60
111-3M	111	37	3,00	3,80	5,80
120-3M	120	40	3,20	4,20	6,00
123-3M	123	41	3,20	4,20	6,00
126-3M	126	42	3,20	4,20	6,00
129-3M	129	43	3,20	4,20	6,00
141-3M	141	47	3,20	4,20	6,00
<b>144-3M</b>	144	48	3,20	4,20	6,00
<b>147-3M</b>	147	49	3,20	4,20	6,00
150-3M	150	50	3,40	4,20	6,10
156-3M	156	52	3,40	4,30	6,20
159-3M	159	53	3,40	4,40	6,30
165-3M	165	55	3,40	4,40	6,30
168-3M	168	56	3,40	4,40	6,40
171-3M	171	57	3,40	4,40	6,40
174-3M	174	58	3,40	4,40	6,40
177-3M	177	59	3,40	4,40	6,40
180-3M	180	60	3,40	4,40	6,40
183-3M	183	61	3,40	4,40	6,40
186-3M	186	62	3,40	4,40	6,40
189-3M	189	63	3,40	4,40	6,40
192-3M	192	64	3,40	4,40	6,40
195-3M	195	65	3,40	4,40	6,40
201-3M	201	67	3,40	4,40	6,50
204-3M	204	68	3,40	4,40	6,50
210-3M	210	70	3,40	4,40	6,50
213-3M	213	71	3,40	4,40	6,50
216-3M	216	72	3,40	4,40	6,50
219-3M	219	73	3,40	4,40	6,50
222-3M	222	74	3,40	4,40	6,50
225-3M	225	75	3,40	4,40	6,60
<b>231-3M</b>	231	77	3,40	4,40	6,60
234-3M	234	78	3,40	4,40	6,60
237-3M	237	79	3,40	4,40	6,60
<b>240-3M</b>	240	80	3,40	4,40	6,60
243-3M	243	81	3,40	4,40	6,60
246-3M	246	82	3,40	4,40	6,60
249-3M	249	83	3,40	4,40	6,60
252-3M	252	84	3,40	4,40	6,60
255-3M	255	85	3,60	4,60	6,90
<b>261-3M</b>	261	87	3,60	4,60	6,90
<b>264-3M</b>	264	88	3,60	4,60	6,90
267-3M	267	89	3,60	4,60	6,90
<b>270-3M</b>	270	90	3,60	4,60	6,90
276-3M	276	92	3,60	4,60	6,90
282-3M	282	94	3,60	4,60	6,90
285-3M	285	95	3,80	4,60	6,90
288-3M	288	96	3,80	4,60	6,90
291-3M	291	97	3,80	4,60	6,90
294-3M	294	98	3,80	4,60	6,90
297-3M	297	99	3,80	4,70	7,00
300-3M	300	100	3,80	4,80	7,10
306-3M	306	102	3,80	4,80	7,10
312-3M	312	104	3,80	4,80	7,20
315-3M	315	105	3,80	4,80	7,20
318-3M	318	106	3,80	4,80	7,30
<b>327-3M</b>	327	109	3,80	4,80	7,30
<b>330-3M</b>	330	110	3,90	5,10	7,40
333-3M	333	111	3,90	5,10	7,40
336-3M	336	112	3,90	5,10	7,40
339-3M	339	113	3,90	5,10	7,40

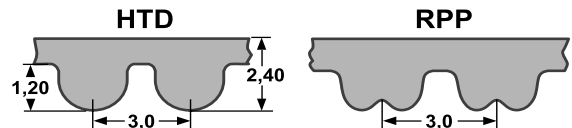

### Type 3M - Teilung/ Pitch 3 mm

Größe size	Wirklänge pitch length mm	Zähnezahl number of teeth	Breite width	Breite width	Breite width
			6 mm	9 mm	15 mm
			Stück/ piece Euro	Stück/ piece Euro	Stück/ piece Euro
342-3M	342	114	3,90	5,10	7,40
345-3M	345	115	3,90	5,10	7,40
357-3M	357	119	3,90	5,10	7,50
363-3M	363	121	3,90	5,10	7,50
372-3M	372	124	3,90	5,10	7,60
<b>375-3M</b>	375	125	4,00	5,20	7,60
381-3M	381	127	4,00	5,20	7,60
384-3M	384	128	4,00	5,20	7,70
<b>390-3M</b>	390	130	4,00	5,20	7,70
393-3M	393	131	4,00	5,20	7,70
<b>405-3M</b>	405	135	4,00	5,20	7,70
420-3M	420	140	4,10	5,20	7,80
<b>432-3M</b>	432	144	4,10	5,20	7,80
435-3M	435	145	4,10	5,20	7,80
447-3M	447	149	4,20	5,40	7,80
462-3M	462	154	4,20	5,40	7,90
474-3M	474	158	4,20	5,50	8,00
477-3M	477	159	4,20	5,50	8,00
480-3M	480	160	4,20	5,50	8,00
486-3M	486	162	4,20	5,50	8,10
489-3M	489	163	4,20	5,50	8,10
501-3M	501	167	4,20	5,50	8,30
<b>510-3M</b>	510	170	4,20	5,50	8,30
513-3M	513	171	4,20	5,50	8,30
522-3M	522	174	4,20	5,50	8,40
525-3M	525	175	4,20	5,50	8,40
531-3M	531	177	4,40	5,50	8,40
537-3M	537	179	4,40	5,60	8,50
552-3M	552	184	4,40	5,60	8,50
558-3M	558	186	4,40	5,60	8,50
564-3M	564	188	4,40	5,60	8,50
570-3M	570	190	4,40	5,70	8,70
573-3M	573	191	4,40	5,70	8,70
<b>576-3M</b>	576	192	4,40	5,70	8,70
<b>579-3M</b>	579	193	4,40	5,70	8,70
582-3M	582	194	4,40	5,70	8,70
591-3M	591	197	4,40	5,70	8,70
594-3M	594	198	4,40	5,70	8,70
<b>597-3M</b>	597	199	4,40	5,70	8,70
600-3M	600	200	4,50	5,70	8,70
612-3M	612	204	4,50	5,80	8,70
627-3M	627	209	4,60	5,90	8,80
633-3M	633	211	4,60	6,00	8,80
645-3M	645	215	4,70	6,10	8,90
648-3M	648	216	4,70	6,20	9,10
669-3M	669	223	4,80	6,30	9,30
672-3M	672	224	4,90	6,30	9,40
681-3M	681	227	5,00	6,40	9,50
711-3M	711	237	5,10	6,40	9,60
720-3M	720	240	5,10	6,40	9,70
735-3M	735	245	5,20	6,50	9,80
738-3M	738	246	5,20	6,50	9,90
753-3M	753	248	5,20	6,60	10,00
<b>756-3M</b>	756	249	5,30	6,70	10,10
804-3M	804	268	5,40	6,90	10,20
822-3M	822	274	5,40	6,90	10,20
882-3M	882	294	5,40	6,90	10,20
945-3M	945	315	5,50	7,10	10,50
981-3M	981	327	5,60	7,20	10,80
1002-3M	1002	334	5,60	7,30	10,90
<b>1062-3M</b>	1062	354	5,70	7,50	11,10
1071-3M	1071	357	5,70	7,50	11,10

HTD / RPP - Neoprene - Zahnflachriemen

HTD / RPP - Neoprene - Timing Belts

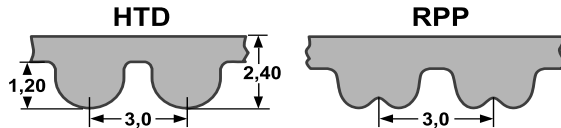

## Type 3M - Teilung/ Pitch 3 mm

Größe size	Wirklänge pitch length mm	Zähnezahl number of teeth	Breite width	Breite width	Breite width
			6 mm	9 mm	15 mm
			Stück/ piece Euro	Stück/ piece Euro	Stück/ piece Euro
1080-3M	1080	360	6,00	7,70	11,50
<b>1125-3M</b>	1125	375	6,00	7,70	11,50
1176-3M	1176	392	6,20	7,90	11,80
1245-3M	1245	415	6,30	8,10	12,00
1263-3M	1263	421	6,30	8,10	12,00
1500-3M	1500	500	6,40	8,40	12,30
1530-3M	1530	510	6,40	8,40	12,30
1863-3M	1863	621	8,00	10,40	15,30
1926-3M	1926	642	8,30	10,80	15,80

Wickelpreise auf Anfrage.

Prices of sleeves on request.

Abmessungen in Fettdruck nur in RPP verfügbar.

Bold-faced dimensions only available in RPP.

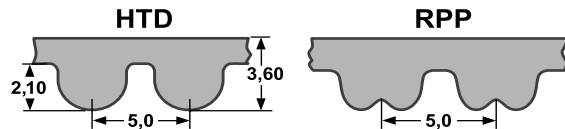

## Type 5M Teilung/ Pitch 5 mm

Größe size	Wirklänge pitch length mm	Zähnezahl number of teeth	Breite width	Breite width	Breite width
			9 mm	15 mm	25 mm
			Stück/ piece Euro	Stück/ piece Euro	Stück/ piece Euro
120-5M	120	24	3,90	5,40	7,70
180-5M	180	36	4,10	6,00	8,70
225-5M	225	45	4,30	6,50	9,50
<b>235-5M</b>	235	47	4,30	6,50	9,60
<b>245-5M</b>	245	49	4,30	6,60	9,80
255-5M	255	51	4,30	6,60	9,90
265-5M	265	53	4,50	6,60	9,90
270-5M	270	54	4,60	6,90	9,90
275-5M	275	55	4,60	7,00	10,20
280-5M	280	56	4,60	7,00	10,20
<b>285-5M</b>	285	57	4,60	7,00	10,30
295-5M	295	59	4,60	7,00	10,30
300-5M	300	60	4,60	7,10	10,50
305-5M	305	61	4,80	7,20	10,50
325-5M	325	65	5,10	7,40	10,80
330-5M	330	66	5,10	7,40	10,80
335-5M	335	67	5,10	7,40	10,90
340-5M	340	68	5,10	7,40	10,90
345-5M	345	69	5,10	7,40	11,10
350-5M	350	70	5,10	7,40	11,10
360-5M	360	72	5,20	7,50	11,40
365-5M	365	73	5,20	7,50	11,40
370-5M	370	74	5,20	7,50	11,40
375-5M	375	75	5,20	7,50	11,40
385-5M	385	77	5,30	7,60	11,50
400-5M	400	80	5,40	7,70	11,60
405-5M	405	81	5,40	7,70	11,70
420-5M	420	84	5,50	7,80	11,90
425-5M	425	85	5,50	7,80	11,90
450-5M	450	90	6,30	9,00	13,50

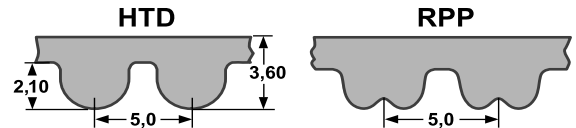

**Type 5M Teilung/ Pitch 5 mm**

Größe size	Wirklänge pitch length mm	Zähnezahl number of teeth	Breite width	Breite width	Breite width
			9 mm	15 mm	25 mm
			Stück/ piece Euro	Stück/ piece Euro	Stück/ piece Euro
<b>455-5M</b>	455	91	6,30	9,00	13,50
460-5M	460	92	6,30	9,20	13,60
<b>465-5M</b>	465	93	6,40	9,20	13,60
475-5M	475	95	6,40	9,30	13,60
500-5M	500	100	6,40	9,60	13,90
510-5M	510	102	6,50	9,70	14,20
520-5M	520	104	6,60	9,80	14,60
525-5M	525	105	6,60	9,80	14,60
535-5M	535	107	6,60	9,80	14,60
550-5M	550	110	6,60	9,80	14,60
560-5M	560	112	6,60	9,90	15,00
565-5M	565	113	6,60	9,90	15,00
575-5M	575	115	6,90	10,20	15,30
580-5M	580	116	6,90	10,20	15,30
600-5M	600	120	7,00	10,50	15,60
610-5M	610	122	7,10	10,70	15,80
615-5M	615	123	7,10	10,80	15,80
635-5M	635	127	7,30	10,90	16,10
640-5M	640	128	7,40	11,10	16,50
645-5M	645	129	7,40	11,10	16,50
665-5M	665	133	7,40	11,20	16,60
670-5M	670	134	7,40	11,20	16,60
<b>675-5M</b>	675	135	7,70	11,40	16,90
695-5M	695	139	7,70	11,40	16,90
700-5M	700	140	7,70	11,40	16,90
<b>705-5M</b>	705	141	7,70	11,40	16,90
710-5M	710	142	7,70	11,40	16,90
720-5M	720	144	7,70	11,60	17,10
<b>725-5M</b>	725	145	7,70	11,60	17,10
740-5M	740	148	7,70	11,60	17,10
750-5M	750	150	7,80	11,70	17,50
755-5M	755	151	7,80	11,70	17,50
770-5M	770	154	8,20	12,40	18,50
775-5M	775	155	8,20	12,40	18,50
800-5M	800	160	8,20	12,40	18,50
825-5M	825	165	8,30	12,70	19,10
835-5M	835	167	8,40	12,70	19,10
<b>850-5M</b>	850	170	8,50	12,80	19,30
860-5M	860	172	8,50	12,80	19,30
870-5M	870	174	8,70	13,00	19,30
890-5M	890	178	8,70	13,00	19,30
900-5M	900	180	8,70	13,00	19,50
925-5M	925	185	8,90	13,30	19,70
935-5M	935	187	9,00	13,50	19,90
940-5M	940	188	9,20	13,50	19,90
950-5M	950	190	9,20	13,50	19,90
965-5M	965	193	9,30	13,60	20,30
980-5M	980	196	9,30	13,90	20,50
1000-5M	1000	200	9,30	13,90	20,80
1025-5M	1025	205	9,50	14,20	21,20
1035-5M	1035	207	9,50	14,20	21,20
1050-5M	1050	210	9,70	14,30	21,30
1100-5M	1100	220	9,70	15,00	22,00
1125-5M	1125	225	10,10	15,00	22,40
1135-5M	1135	227	10,30	15,30	22,70
1175-5M	1175	235	10,50	15,50	23,10
<b>1195-5M</b>	1195	239	10,70	15,70	23,40
1200-5M	1200	240	10,70	15,70	23,50
1225-5M	1225	245	10,80	15,80	23,70
<b>1240-5M</b>	1240	248	10,80	16,00	23,90
1270-5M	1270	254	10,90	16,10	24,20
1350-5M	1350	270	11,70	17,50	26,10

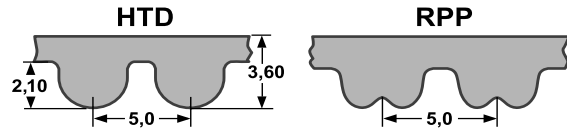

### Type 5M Teilung/ Pitch 5 mm

Größe size	Wirklänge pitch length mm	Zähnezahl number of teeth	Breite width 9 mm	Breite width 15 mm	Breite width 25 mm
			Stück/ piece Euro	Stück/ piece Euro	Stück/ piece Euro
1380-5M	1380	276	11,80	17,60	16,20
1420-5M	1420	284	11,90	17,70	26,30
<b>1500-5M</b>	1500	300	12,40	18,40	27,30
1595-5M	1595	319	12,90	19,10	28,40
<b>1605-5M</b>	1605	321	12,90	19,20	28,60
1690-5M	1690	338	13,40	19,70	29,40
1790-5M	1790	358	14,00	20,90	31,10
<b>1800-5M</b>	1800	360	14,00	20,90	31,40
1870-5M	1870	374	14,40	21,30	31,90
<b>1895-5M</b>	1895	379	14,80	21,90	32,50
<b>1945-5M</b>	1945	389	15,10	22,30	33,20
<b>2000-5M</b>	2000	400	15,40	22,70	33,90
2100-5M	2100	420	16,10	24,50	35,70
<b>2250-5M</b>	2250	450	17,20	25,90	38,10
2350-5M	2350	470	17,90	27,00	39,90
<b>2525-5M</b>	2525	505	18,50	27,40	40,70

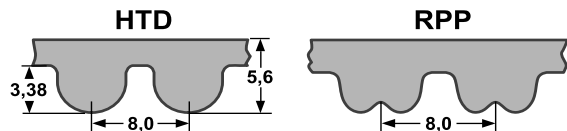

### Type 8M - Teilung/ Pitch 8 mm

Größe size	Wirklänge pitch length mm	Zähnezahl number of teeth	Breite width 20 mm	Breite width 30 mm	Breite width 50 mm	Breite width 85 mm
			Stück/ piece Euro	Stück/ piece Euro	Stück/ piece Euro	Stück/ piece Euro
264-8M	264	33	7,90	11,60	19,20	31,20
<b>288-8M</b>	288	36	8,60	12,60	20,90	34,00
320-8M	320	40	9,50	14,00	23,20	37,80
<b>352-8M</b>	352	44	9,80	15,00	24,80	42,60
<b>360-8M</b>	360	45	9,80	15,00	24,80	42,60
376-8M	376	47	9,80	15,00	24,80	42,60
384-8M	384	48	10,20	15,40	25,40	43,70
<b>408-8M</b>	408	51	10,50	15,70	26,10	44,60
<b>416-8M</b>	416	52	10,70	15,80	26,30	45,00
424-8M	424	53	10,80	16,00	26,50	45,50
<b>456-8M</b>	456	57	11,10	16,60	27,50	47,00
480-8M	480	60	11,30	17,00	28,20	48,10
512-8M	512	64	12,20	18,00	30,20	50,90
520-8M	520	65	12,30	18,50	30,50	51,60
<b>536-8M</b>	536	67	12,60	18,70	31,00	52,50
<b>544-8M</b>	544	68	12,70	18,90	31,40	53,10
560-8M	560	70	12,80	19,10	32,10	53,90
576-8M	576	72	13,00	19,50	32,40	55,30
600-8M	600	75	13,20	19,80	32,80	55,90
608-8M	608	76	13,40	19,90	33,20	56,60
624-8M	624	78	13,80	20,50	34,30	57,90
<b>632-8M</b>	632	79	13,80	20,70	34,50	58,60
640-8M	640	80	13,90	20,80	34,60	59,50
656-8M	656	82	14,40	21,70	35,80	61,50
<b>680-8M</b>	680	85	14,40	21,40	36,00	61,10
720-8M	720	90	15,10	22,30	37,50	63,50
760-8M	760	95	15,60	23,30	39,10	66,70
776-8M	776	97	15,80	23,70	39,80	68,00
800-8M	800	100	16,00	24,20	40,20	68,90
<b>840-8M</b>	840	105	16,70	24,90	41,20	70,50
856-8M	856	107	16,80	25,10	41,60	71,10
880-8M	880	110	17,00	25,40	42,20	71,90

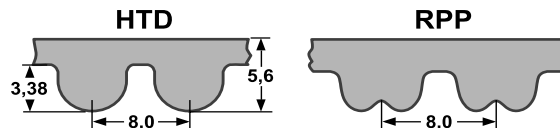

### Type 8M - Teilung/ Pitch 8 mm

Größe size	Wirklänge pitch length mm	Zähnezahl number of teeth	Breite width	Breite width	Breite width	Breite width
			20 mm	30 mm	50 mm	85 mm
			Stück/ piece Euro	Stück/ piece Euro	Stück/ piece Euro	Stück/ piece Euro
<b>896-8M</b>	896	112	17,40	26,00	43,20	73,20
912-8M	912	114	17,80	26,50	44,10	74,40
920-8M	920	115	17,90	26,50	44,30	75,20
960-8M	960	120	18,10	27,30	45,40	77,40
968-8M	968	121	18,50	27,40	45,80	77,80
976-8M	976	122	18,60	27,60	46,00	78,50
1000-8M	1000	125	19,00	28,20	46,90	79,80
1040-8M	1040	130	19,60	29,20	48,50	82,40
1064-8M	1064	133	19,80	29,50	49,50	83,70
1080-8M	1080	135	20,00	30,20	50,00	85,50
1120-8M	1120	140	20,70	30,70	51,50	88,00
1128-8M	1128	141	20,80	31,00	51,40	88,50
1160-8M	1160	145	21,10	31,50	52,70	90,00
1176-8M	1176	147	21,40	31,90	53,20	90,80
1200-8M	1200	150	21,80	32,40	53,90	91,90
1216-8M	1216	152	22,00	32,90	54,20	92,20
1224-8M	1224	153	22,20	33,10	55,30	93,20
1256-8M	1256	157	22,70	33,80	56,60	95,60
1264-8M	1264	158	22,70	33,90	56,60	96,10
1280-8M	1280	160	22,90	34,30	57,00	97,50
1304-8M	1304	163	23,70	34,80	58,90	99,40
<b>1352-8M</b>	1352	169	23,90	35,40	59,50	100,40
1360-8M	1360	170	24,20	36,00	60,20	101,80
1424-8M	1424	178	24,80	37,00	61,80	105,50
1432-8M	1432	179	24,90	37,10	62,30	105,60
1440-8M	1440	180	25,00	37,30	62,30	105,80
<b>1464-8M</b>	1464	183	25,30	36,10	63,10	107,80
1512-8M	1512	189	25,90	38,60	63,90	109,80
1520-8M	1520	190	26,10	38,70	64,10	110,20
1552-8M	1552	194	26,40	39,40	65,70	112,00
1584-8M	1584	198	26,80	40,00	67,20	113,20
1600-8M	1600	200	27,20	40,50	67,90	114,30
<b>1680-8M</b>	1680	210	28,20	41,90	70,40	118,90
1696-8M	1696	212	28,40	42,20	70,90	119,80
1728-8M	1728	216	28,90	42,90	71,90	121,70
1760-8M	1760	220	29,20	43,70	72,90	123,80
1800-8M	1800	225	29,60	44,60	73,80	125,70
1896-8M	1896	237	31,00	45,00	77,60	132,10
1904-8M	1904	238	31,20	45,40	77,90	132,70
2000-8M	2000	250	32,80	47,60	81,90	139,30
2080-8M	2080	260	32,90	48,90	87,40	145,60
<b>2200-8M</b>	2200	275	35,20	52,50	88,90	150,50
2240-8M	2240	280	36,00	53,80	89,30	152,10
2272-8M	2272	284	36,50	54,20	90,30	153,50
2400-8M	2400	300	38,50	57,40	96,00	162,30
2504-8M	2504	313	39,90	59,50	99,20	168,40
<b>2520-8M</b>	2520	315	40,10	59,80	99,70	169,30
2600-8M	2600	325	41,20	61,40	102,10	174,00
2800-8M	2800	350	44,10	64,30	109,40	186,30
<b>3048-8M</b>	3048	381	47,90	70,10	118,90	202,70
<b>3280-8M</b>	3280	410	51,60	75,40	128,10	218,20
<b>3600-8M</b>	3600	450	56,60	82,90	140,60	239,40
<b>4400-8M</b>	4400	550	69,60	101,40	171,80	292,70

Wickelpreise auf Anfrage.

Prices of sleeves on request.

Abmessungen in Fettdruck nur in RPP verfügbar.

Bold-faced dimensions only available in RPP.

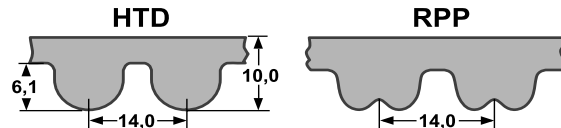

### Type 14M - Teilung/ Pitch 14 mm

Größe size	Wirklänge pitch length mm	Zähnezahl number of teeth	Breite width	Breite width	Breite width	Breite width	Breite width
			40 mm	55 mm	85 mm	115 mm	170 mm
			Stück/ piece Euro	Stück/ piece Euro	Stück/ piece Euro	Stück/ piece Euro	Stück/ piece Euro
784-14M	784	56	74,60	100,60	154,50	208,70	307,90
826-14M	826	59	78,60	106,00	162,80	219,90	324,30
924-14M	924	66	87,90	118,70	182,20	246,10	362,90
966-14M	966	69	88,90	122,40	189,10	255,70	377,80
<b>994-14M</b>	994	71	89,80	123,60	191,30	258,60	381,70
1092-14M	1092	78	92,90	127,80	198,90	268,70	395,40
<b>1106-14M</b>	1106	79	93,30	128,40	199,70	269,40	396,80
1190-14M	1190	85	95,60	132,00	204,50	273,80	405,20
<b>1260-14M</b>	1260	90	98,20	135,90	210,50	282,70	418,00
<b>1288-14M</b>	1288	92	99,70	137,20	213,70	287,10	424,40
<b>1344-14M</b>	1344	96	101,60	140,50	218,00	293,60	433,90
1400-14M	1400	100	103,60	143,80	222,20	300,10	443,40
<b>1442-14M</b>	1442	103	103,70	146,00	225,60	304,60	450,30
<b>1568-14M</b>	1568	112	104,10	152,80	236,00	318,30	471,20
1610-14M	1610	115	116,10	155,30	239,30	323,00	477,80
<b>1750-14M</b>	1750	125	119,70	164,40	253,10	341,80	504,10
<b>1764-14M</b>	1764	126	120,10	165,30	254,50	343,70	506,70
1778-14M	1778	127	120,90	167,30	257,60	347,90	513,60
<b>1848-14M</b>	1848	132	122,90	170,60	263,50	355,30	524,70
1890-14M	1890	135	124,10	172,60	267,10	359,70	531,30
<b>1904-14M</b>	1904	136	124,70	173,40	268,30	361,40	533,70
<b>1960-14M</b>	1960	140	127,20	176,40	273,30	368,00	543,50
2100-14M	2100	150	133,30	183,80	285,70	384,60	568,10
<b>2240-14M</b>	2240	160	139,40	192,10	297,20	400,90	592,00
2310-14M	2310	165	142,40	196,30	302,90	409,00	603,90
<b>2380-14M</b>	2380	170	145,20	200,90	309,60	418,50	618,00
2450-14M	2450	175	148,00	205,50	316,30	428,10	632,10
2590-14M	2590	185	152,30	210,60	325,80	440,00	650,20
<b>2660-14M</b>	2660	190	155,80	215,60	337,30	450,10	665,00
2800-14M	2800	200	162,90	225,50	360,30	470,20	694,70
<b>2968-14M</b>	2968	212	167,90	234,30	365,10	485,00	716,50
3150-14M	3150	225	173,40	243,80	370,20	501,10	740,10
<b>3360-14M</b>	3360	240	187,90	254,50	390,80	529,30	781,10
3500-14M	3500	250	190,30	261,80	404,70	548,10	808,40
3850-14M	3850	275	205,50	284,30	439,00	593,00	876,20
<b>3920-14M</b>	3920	280	209,30	289,60	446,60	603,60	895,80
4004-14M	4004	286	213,90	295,90	455,80	616,20	919,20
4326-14M	4326	309	227,00	313,80	484,50	654,10	991,40
4578-14M	4578	327	237,50	328,20	506,90	685,20	1012,40
<b>4956-14M</b>	4956	354	258,80	357,70	552,50	746,80	1103,10

Type 20M auf Anfrage.

Type 20M on request.

Abmessungen in Fettdruck nur in RPP verfügbar.

Bold-faced dimensions only available in RPP.

Wickelpreise auf Anfrage.

Prices of sleeves on request.

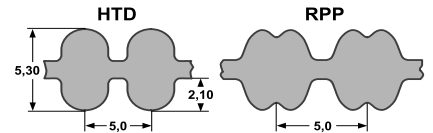

### Type D 5M - Teilung/ Pitch 5 mm

Größe size	Wirklänge pitch length mm	Zähnezahl number of teeth	Breite width	Breite width	Breite width
			9 mm	15 mm	25 mm
			Stück/ piece Euro	Stück/ piece Euro	Stück/ piece Euro
600 D 5M	600	120	38,40	57,70	85,70
610 D 5M	610	122	39,10	58,90	87,00
615 D 5M	615	123	39,10	59,40	86,90
635 D 5M	635	127	40,20	60,00	88,60
640 D 5M	640	128	40,70	61,00	90,70
670 D 5M	670	134	40,70	61,50	91,20
675 D 5M	675	135	42,30	62,60	92,90
700 D 5M	700	140	42,30	62,70	92,90
705 D 5M	705	141	42,30	62,70	92,90
710 D 5M	710	142	42,30	62,70	92,90
725 D 5M	725	145	42,40	63,80	94,10
740 D 5M	740	148	42,30	63,80	94,00
750 D 5M	750	150	42,90	64,30	96,20
755 D 5M	755	151	42,90	64,30	96,20
800 D 5M	800	160	45,10	68,20	101,70
835 D 5M	835	167	46,20	69,90	105,10
850 D 5M	850	170	46,70	70,30	106,10
890 D 5M	890	178	47,80	71,50	106,10
900 D 5M	900	180	47,80	71,50	107,20
935 D 5M	935	187	49,50	74,20	109,40
940 D 5M	940	188	50,60	74,20	109,40
950 D 5M	950	190	50,60	74,30	109,50
980 D 5M	980	196	51,10	76,40	112,60
1000 D 5M	1000	200	51,20	76,50	114,40
1025 D 5M	1025	205	52,20	78,00	116,50
1050 D 5M	1050	210	53,40	78,70	117,30
1100 D 5M	1100	220	53,40	82,50	121,00
1125 D 5M	1125	225	55,50	82,40	123,10
1135 D 5M	1135	227	56,60	84,10	124,80
1195 D 5M	1195	239	58,80	86,30	128,70
1200 D 5M	1200	240	58,90	86,40	129,40
1240 D 5M	1240	248	59,40	88,00	131,40
1270 D 5M	1270	254	60,00	88,60	133,20
1420 D 5M	1420	284	65,40	97,30	144,50
1500 D 5M	1500	300	68,20	101,30	150,20
1595 D 5M	1595	319	71,00	105,10	156,30
1605 D 5M	1605	321	71,00	105,60	157,30
1690 D 5M	1690	338	73,70	108,40	161,80
1790 D 5M	1790	358	76,90	114,90	170,90
1800 D 5M	1800	360	77,00	115,00	172,70
1870 D 5M	1870	374	79,20	117,10	175,40
1895 D 5M	1895	379	81,40	120,50	178,80
1945 D 5M	1945	389	83,00	122,60	182,60
2000 D 5M	2000	400	84,70	124,80	186,40
2250 D 5M	2250	450	94,60	142,50	209,60
2525 D 5M	2525	505	101,70	150,60	223,70
<p>Preise gültig für RPP. HTD auf Anfrage.                      Prices are available for RPP. HTD on request.</p> <p>Abmessungen in Fettdruck auf Anfrage.                      Bold-faced dimensions on request.</p> <p>Wickelpreise auf Anfrage.                      Prices of sleeves on request.</p>					

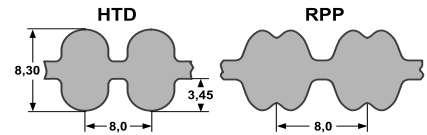

### Type D 8M - Teilung/ Pitch 8 mm

Größe size	Wirklänge pitch length mm	Zähnezahl number of teeth	Breite width	Breite width	Breite width	Breite width
			20 mm	30 mm	50 mm	85 mm
			Stück/ piece Euro	Stück/ piece Euro	Stück/ piece Euro	Stück/ piece Euro
600 D 8M	600	75	52,80	79,20	131,20	223,60
608 D 8M	608	76	53,60	79,60	132,80	226,40
632 D 8M	632	79	55,20	82,90	138,10	234,60
640 D 8M	640	80	55,60	83,20	138,50	238,10
680 D 8M	680	85	57,60	85,60	144,00	244,40
720 D 8M	720	90	60,40	89,20	150,00	254,00
800 D 8M	800	100	64,00	96,80	160,90	275,70
840 D 8M	840	105	66,80	99,60	164,80	282,00
880 D 8M	880	110	68,00	101,60	168,70	287,50
896 D 8M	896	112	69,60	104,00	172,80	292,80
920 D 8M	920	115	71,60	106,00	177,30	300,90
960 D 8M	960	120	72,40	109,20	181,70	309,70
1000 D 8M	1000	110	76,00	112,80	187,50	319,10
1040 D 8M	1040	130	78,40	116,80	194,10	329,70
1080 D 8M	1080	135	80,00	120,80	200,00	342,00
1120 D 8M	1120	140	82,80	122,80	206,00	352,00
1200 D 8M	1200	150	87,20	129,60	215,60	367,60
1224 D 8M	1224	153	88,80	132,40	221,20	372,80
1280 D 8M	1280	160	91,60	137,20	227,90	389,90
1352 D 8M	1352	169	95,60	141,60	238,00	401,60
1424 D 8M	1424	178	99,20	148,00	247,20	422,00
1440 D 8M	1440	180	100,00	149,20	249,20	423,20
1464 D 8M	1464	183	101,20	144,40	252,40	431,20
1600 D 8M	1600	200	108,80	162,00	271,70	457,30
1680 D 8M	1680	210	112,80	167,60	281,70	475,70
1760 D 8M	1760	220	116,80	174,80	291,50	495,10
1800 D 8M	1800	225	118,40	178,40	295,10	502,70
2000 D 8M	2000	250	131,20	190,40	327,60	557,20
2200 D 8M	2200	275	140,80	210,00	355,60	602,00
2272 D 8M	2272	284	146,00	216,80	361,10	613,90
2400 D 8M	2400	300	154,00	229,60	384,00	649,20
2520 D 8M	2520	315	160,40	239,20	398,80	677,20
2600 D 8M	2600	325	164,80	245,60	408,30	695,90
2800 D 8M	2800	350	176,40	257,20	437,70	745,30
3048 D 8M	3048	381	191,60	280,40	475,60	810,70
3280 D 8M	3280	410	206,40	301,60	512,40	872,80
3600 D 8M	3600	450	226,40	331,60	562,40	957,50
4400 D 8M	4400	550	278,40	405,50	687,10	1170,60

Preise gültig für RPP. HTD auf Anfrage.

Prices are available for RPP. HTD on request.

Abmessungen in Fettdruck auf Anfrage.

Bold-faced dimensions on request.

Wickelpreise auf Anfrage.

Prices of sleeves on request.

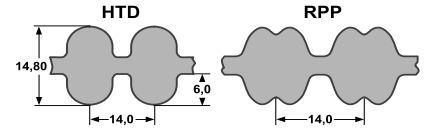

**Type D 14M - Teilung/ Pitch 14 mm**

Größe size	Wirklänge pitch length mm	Zähnezahl number of teeth	Breite width	Breite width	Breite width	Breite width	Breite width
			40 mm	55 mm	85 mm	115 mm	170 mm
			Stück/ piece Euro	Stück/ piece Euro	Stück/ piece Euro	Stück/ piece Euro	Stück/ piece Euro
966 D 14M	966	69	355,60	489,60	756,40	1022,80	1511,20
994 D 14M	994	71	359,20	494,40	765,20	1034,40	1526,80
1092 D 14M	1092	78	371,60	511,20	795,50	1074,70	1581,50
1106 D 14M	1106	79	373,20	513,60	798,80	1077,60	1587,20
1190 D 14M	1190	85	382,50	528,10	818,10	1095,40	1621,00
1260 D 14M	1260	90	392,80	543,60	842,00	1130,80	1672,00
1288 D 14M	1288	92	398,80	548,80	854,80	1148,40	1697,60
1344 D 14M	1344	96	406,40	562,00	871,90	1174,30	1735,50
1400 D 14M	1400	100	414,40	575,20	888,80	1200,40	1773,60
1442 D 14M	1442	103	414,80	584,10	902,50	1218,50	1801,40
1568 D 14M	1568	112	416,40	611,20	944,00	1273,20	1884,80
1610 D 14M	1610	115	464,40	621,20	957,20	1292,00	1911,20
1750 D 14M	1750	125	478,80	657,60	1012,40	1367,20	2016,40
1764 D 14M	1764	126	480,40	661,20	1018,10	1374,90	2026,90
1778 D 14M	1778	127	483,60	669,20	1030,40	1391,60	2054,40
1848 D 14M	1848	132	491,50	682,30	1053,90	1421,00	2098,60
1890 D 14M	1890	135	496,40	690,40	1068,50	1438,90	2125,30
1904 D 14M	1904	136	498,80	693,60	1073,20	1445,60	2134,80
1960 D 14M	1960	140	508,80	705,60	1093,30	1472,10	2174,10
2100 D 14M	2100	150	533,20	735,20	1142,80	1538,40	2272,40
2240 D 14M	2240	160	557,60	768,40	1188,80	1603,60	2368,00
2310 D 14M	2310	165	569,60	785,20	1211,70	1636,10	2415,70
2380 D 14M	2380	170	580,80	803,60	1238,40	1674,00	2472,00
2450 D 14M	2450	175	592,00	822,00	1265,20	1712,40	2528,40
2590 D 14M	2590	185	609,20	842,40	1303,20	1760,10	2600,90
2660 D 14M	2660	190	623,20	862,40	1349,20	1800,40	2660,00
2800 D 14M	2800	200	651,60	902,00	1441,20	1880,80	2778,80
2968 D 14M	2968	212	671,60	937,20	1460,40	1939,90	2865,90
3150 D 14M	3150	225	693,60	975,20	1480,70	2004,30	2960,30
3360 D 14M	3360	240	751,60	1018,00	1563,20	2117,30	3124,50
3500 D 14M	3500	250	761,20	1047,20	1618,80	2192,40	3233,60
3850 D 14M	3850	275	822,00	1137,20	1756,00	2372,00	3504,80
3920 D 14M	3920	280	837,20	1158,40	1786,30	2414,30	3583,10
4326 D 14M	4326	309	908,00	1255,20	1938,00	2616,50	3965,70
4578 D 14M	4578	327	950,00	1312,80	2027,60	2740,70	4049,50
4956 D 14M	4956	354	1035,10	1430,70	2209,80	2986,90	4412,00

Preise gültig für RPP. HTD auf Anfrage.

Prices are available for RPP. HTD on request.

Abmessungen in Fettdruck auf Anfrage.

Bold-faced dimensions on request.

Wickelpreise auf Anfrage.

Prices of sleeves on request.

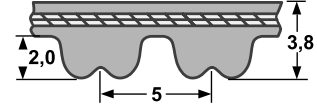

### Type SLV 5 - Teilung/ Pitch 8 mm

Größe size	Wirklänge pitch length mm	Zähnezahl number of teeth	Breite width	Breite width	Breite width
			9 mm	15 mm	25 mm
			Stück/ piece Euro	Stück/ piece Euro	Stück/ piece Euro
180 SLV 5 *	180	36	4,90	7,20	10,40
225 SLV 5 *	225	45	5,20	7,80	11,40
235 SLV 5 *	235	47	5,20	7,80	11,50
245 SLV 5 *	245	29	5,20	7,90	11,80
255 SLV 5 *	255	51	5,20	7,90	11,90
265 SLV 5 *	265	53	5,40	7,90	11,90
270 SLV 5 *	270	54	5,50	8,30	11,90
280 SLV 5	280	56	5,50	8,40	12,20
285 SLV 5 *	285	57	5,50	8,40	12,20
295 SLV 5 *	295	59	5,50	8,40	12,40
300 SLV 5 *	300	60	5,50	8,50	12,60
305 SLV 5 *	305	61	5,80	8,60	12,60
325 SLV 5	325	65	6,10	8,90	13,00
345 SLV 5 *	345	69	6,10	8,90	13,30
350 SLV 5	350	70	6,10	8,90	13,30
375 SLV 5	375	75	6,20	9,00	13,70
400 SLV 5	400	80	6,50	9,20	13,90
420 SLV 5 *	420	84	6,60	9,40	14,30
425 SLV 5	425	85	6,60	9,40	14,30
450 SLV 5	450	90	7,60	10,80	16,20
455 SLV 5 *	455	91	7,60	10,80	16,20
460 SLV 5 *	460	92	7,60	11,00	16,30
465 SLV 5 *	465	93	7,70	11,00	16,30
475 SLV 5	475	95	7,70	11,20	16,30
500 SLV 5	500	100	7,70	11,50	16,70
525 SLV 5	525	105	7,90	11,80	17,50
535 SLV 5 *	535	107	7,90	11,80	17,50
565 SLV 5 *	565	113	7,90	11,90	18,00
575 SLV 5 *	575	115	8,30	12,20	18,40
580 SLV 5 *	580	116	8,30	12,20	18,40
600 SLV 5	600	120	8,40	12,60	18,70
610 SLV 5 *	610	122	8,50	12,80	19,00
615 SLV 5 *	615	123	8,50	13,00	19,00
635 SLV 5 *	635	127	8,80	13,10	19,30
640 SLV 5	640	128	8,90	13,30	19,80
670 SLV 5	670	134	8,90	13,40	19,90
675 SLV 5	675	135	9,20	13,70	20,30
700 SLV 5	700	140	9,20	13,70	20,30
705 SLV 5 *	705	141	9,20	13,70	20,30
710 SLV 5 *	710	142	9,20	13,70	20,30
725 SLV 5 *	725	145	9,20	13,90	20,50
740 SLV 5 *	740	158	9,20	13,90	20,50
750 SLV 5	750	150	9,40	14,00	21,00
755 SLV 5 *	755	151	9,40	14,00	21,00
800 SLV 5	800	160	9,80	14,90	22,20
835 SLV 5 *	835	167	10,10	15,20	22,90
850 SLV 5	850	170	10,20	15,40	23,20
890 SLV 5 *	890	178	10,40	15,60	23,20
900 SLV 5	900	180	10,40	15,60	23,40
935 SLV 5 *	935	187	10,80	16,20	23,90
940 SLV 5 *	940	188	11,00	16,20	23,90
950 SLV 5	950	190	11,00	16,20	23,90
980 SLV 5 *	980	196	11,20	16,70	24,60
1000 SLV 5	1000	200	11,20	16,70	25,00
1025 SLV 5 *	1025	205	11,40	17,00	25,40
1050 SLV 5	1050	210	11,60	17,20	25,60
1100 SLV 5	1100	220	11,60	18,00	26,40
1125 SLV 5 *	1125	225	12,10	18,00	26,90
1135 SLV 5 *	1135	227	12,40	18,40	27,20
1195 SLV 5 *	1195	239	12,80	18,80	28,10
1200 SLV 5 *	1200	240	12,80	18,80	28,20

## RPP Silver - Neoprene - Zahnflachriemen RPP Silver - Neoprene - Timing Belts

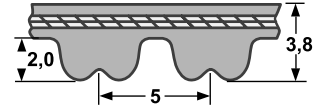

### Type SLV 5 - Teilung/ Pitch 8 mm

Größe size	Wirklänge pitch length mm	Zähnezahl number of teeth	Breite width	Breite width	Breite width
			9 mm	15 mm	25 mm
			Stück/ piece Euro	Stück/ piece Euro	Stück/ piece Euro
1240 SLV 5	1240	248	13,00	19,20	28,70
1270 SLV 5 *	1270	254	13,10	19,30	29,00
1420 SLV 5 *	1420	284	14,30	21,20	31,60
1500 SLV 5 *	1500	300	14,60	21,50	32,10
1595 SLV 5 *	1595	319	15,50	22,90	34,10
1605 SLV 5 *	1605	321	15,60	23,00	34,30
1690 SLV 5 *	1690	338	16,10	23,60	35,30
1790 SLV 5 *	1790	358	16,80	25,10	37,30
1800 SLV 5 *	1800	360	16,80	25,10	37,70
1870 SLV 5 *	1870	374	17,30	25,60	38,30
1895 SLV 5 *	1895	379	17,80	26,30	39,00
1945 SLV 5 *	1945	389	18,00	26,50	39,60
2000 SLV 5 *	2000	400	18,50	27,20	40,70
2250 SLV 5 *	2250	450	20,60	31,10	45,70
2525 SLV 5 *	2525	505	22,20	32,90	48,80
<p>* Diese Abmessungen sind mit Mindestmengen und Lieferzeit verfügbar.</p> <p>* These dimensions are available with minimum quantities and delivery time.</p> <p>Wickelpreise auf Anfrage.</p> <p>Prices of sleeves on request.</p> <p>HTD GT3 auf Anfrage.</p> <p>HTD GT3 on request.</p>					

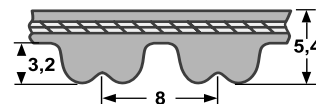

### Type SLV 8 - Teilung/ Pitch 8 mm

Größe size	Wirklänge pitch length mm	Zähnezahl number of teeth	Breite width	Breite width	Breite width	Breite width
			20 mm	30 mm	50 mm	85 mm
			Stück/ piece Euro	Stück/ piece Euro	Stück/ piece Euro	Stück/ piece Euro
288 SLV 8	288	36	10,20	15,10	25,10	40,90
320 SLV 8	320	40	11,40	16,80	27,90	45,30
352 SLV 8	352	44	11,80	18,00	29,70	51,10
360 SLV 8	360	45	11,90	18,10	30,00	51,50
384 SLV 8	384	48	12,20	18,50	30,50	52,40
408 SLV 8	408	51	12,60	18,80	31,30	53,50
416 SLV 8	416	52	12,60	18,90	31,40	53,70
456 SLV 8	456	57	12,80	19,30	32,10	54,80
480 SLV 8	480	60	13,50	20,50	33,80	57,70
536 SLV 8	536	67	15,10	22,40	37,10	63,00
544 SLV 8	544	68	15,30	22,70	37,70	63,70
560 SLV 8	560	70	15,40	23,00	38,50	64,80
600 SLV 8	600	75	15,80	23,80	39,40	67,10
608 SLV 8	608	76	16,00	23,90	39,80	67,90
632 SLV 8	632	79	16,60	24,80	41,30	70,30
640 SLV 8	640	80	16,70	25,00	41,60	71,40
680 SLV 8	680	85	17,20	25,80	43,20	73,40
720 SLV 8	720	90	18,10	26,80	45,00	76,20
800 SLV 8	800	100	19,20	29,10	48,30	82,70
840 SLV 8	840	105	20,00	29,80	49,50	84,70
880 SLV 8	880	110	20,50	30,50	50,60	86,20
896 SLV 8	896	112	21,00	31,10	51,80	87,80
920 SLV 8	920	115	21,40	31,80	53,20	90,20
960 SLV 8	960	120	21,80	32,70	54,50	92,90
1000 SLV 8	1000	125	22,80	33,80	56,30	95,70
1040 SLV 8	1040	130	23,40	35,00	58,30	98,80
1080 SLV 8	1080	135	24,00	36,30	59,90	102,60
1120 SLV 8	1120	140	24,80	36,90	61,80	105,60
1200 SLV 8	1200	150	26,10	38,90	64,80	110,20
1224 SLV 8	1224	153	26,60	39,70	66,30	111,90
1280 SLV 8	1280	160	27,40	41,10	68,40	117,00
1352 SLV 8	1352	169	28,60	42,50	71,40	120,50
1424 SLV 8	1424	178	29,70	42,90	74,20	125,70
1440 SLV 8	1440	180	30,00	43,00	74,80	126,90
1464 SLV 8	1464	183	30,40	43,30	75,70	129,30
1600 SLV 8	1600	200	32,60	48,50	81,50	137,20
1680 SLV 8	1680	210	33,80	50,40	84,40	142,90
1760 SLV 8	1760	220	35,00	52,40	87,40	148,60
1800 SLV 8	1800	225	35,60	53,50	88,70	150,80
2000 SLV 8	2000	250	39,40	57,20	98,30	167,10
2200 SLV 8	2200	275	42,20	63,00	106,70	180,50
2272 SLV 8	2272	274	43,60	65,10	109,80	185,70
2400 SLV 8	2400	300	46,20	68,90	115,20	194,80
2520 SLV 8	2520	315	48,00	71,40	118,80	202,40
2600 SLV 8	2600	325	49,50	73,60	122,60	208,80
2800 SLV 8	2800	350	53,00	77,20	131,30	223,50
3048 SLV 8	3048	381	57,50	84,10	142,70	243,30
3280 SLV 8	3280	410	61,90	90,40	153,80	261,90
3600 SLV 8	3600	450	67,90	99,50	168,70	287,30
4400 SLV 8	4400	550	83,60	121,60	206,20	351,30
Wickelpreise auf Anfrage. Prices of sleeves on request.						
HTD GT3 auf Anfrage. HTD GT3 on request.						

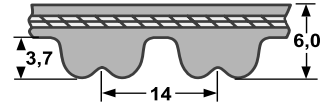

### Type SLV 14 - Teilung/ Pitch 14 mm

Größe size	Wirklänge pitch length mm	Zähnezahl number of teeth	Breite width	Breite width	Breite width	Breite width	Breite width
			40 mm	55 mm	85 mm	115 mm	170 mm
			Stück/ piece Euro	Stück/ piece Euro	Stück/ piece Euro	Stück/ piece Euro	Stück/ piece Euro
966 SLV 14	966	69	106,70	146,80	227,00	306,90	453,50
994 SLV 14	994	71	108,20	149,00	230,80	312,00	461,10
1092 SLV 14	1092	78	111,40	153,30	238,70	322,50	474,50
1106 SLV 14	1106	79	112,90	155,30	241,70	326,60	480,70
1190 SLV 14	1190	85	114,70	158,40	245,40	328,50	486,20
1260 SLV 14	1260	90	117,80	163,10	252,60	339,20	501,60
1288 SLV 14	1288	92	119,60	164,60	256,50	344,50	509,30
1344 SLV 14	1344	96	122,00	168,60	261,60	352,30	520,70
1400 SLV 14	1400	100	124,30	172,60	266,60	360,20	532,10
1442 SLV 14	1442	103	124,60	177,80	274,60	370,90	548,00
1568 SLV 14	1568	112	124,90	183,30	283,20	381,90	565,30
1610 SLV 14	1610	115	139,30	186,40	287,20	387,60	573,30
1750 SLV 14	1750	125	143,60	197,20	303,70	410,30	604,90
1764 SLV 14	1764	126	144,00	198,30	305,30	412,50	608,10
1778 SLV 14	1778	127	145,10	200,80	309,10	417,40	616,30
1848 SLV 14	1848	132	147,50	203,80	314,00	424,10	626,10
1890 SLV 14	1890	135	149,00	207,10	320,50	431,70	637,50
1904 SLV 14	1904	136	150,00	208,70	322,90	434,90	642,30
1960 SLV 14	1960	140	154,40	214,80	332,40	447,60	661,20
2100 SLV 14	2100	150	160,00	220,70	342,80	461,50	681,70
2240 SLV 14	2240	160	165,70	228,40	352,40	476,00	702,90
2310 SLV 14	2310	165	170,90	235,60	363,50	490,80	724,70
2380 SLV 14	2380	170	172,60	239,60	368,70	499,00	736,90
2450 SLV 14	2450	175	177,60	246,60	379,50	513,80	758,60
2590 SLV 14	2590	185	182,80	252,70	390,90	528,00	780,20
2660 SLV 14	2660	190	185,70	257,10	410,70	535,90	792,00
2800 SLV 14	2800	200	195,60	270,60	432,30	564,20	833,60
2968 SLV 14	2968	212	201,60	281,10	438,10	582,00	859,80
3150 SLV 14	3150	225	208,20	292,50	444,30	601,40	888,10
3360 SLV 14	3360	240	225,50	305,30	468,90	635,20	937,30
3500 SLV 14	3500	250	228,30	314,20	485,60	657,80	970,20
3850 SLV 14	3850	275	246,60	341,10	526,80	711,60	1051,40
3920 SLV 14	3920	280	251,50	349,70	539,90	729,40	1077,90
4326 SLV 14	4326	309	272,40	376,60	581,50	784,90	1189,70
4578 SLV 14	4578	327	285,00	393,90	608,20	822,20	1214,90
4956 SLV 14	4956	354	308,40	426,40	658,50	890,10	1315,20
Wickelpreise auf Anfrage. Prices of sleeves on request.							
HTD GT3 auf Anfrage. HTD GT3 on request.							

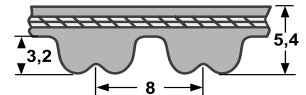

**Type GLD 8 - Teilung/ Pitch 8 mm**

Größe size	Wirklänge pitch length mm	Zähnezahl number of teeth	Breite width	Breite width	Breite width	Breite width
			20 mm	30 mm	50 mm	85 mm
			Stück/ piece Euro	Stück/ piece Euro	Stück/ piece Euro	Stück/ piece Euro
288 GLD 8	288	36	34,00	52,70	89,20	152,40
320 GLD 8	320	40	36,60	57,00	94,80	163,60
352 GLD 8	352	44	39,00	60,70	102,30	175,30
360 GLD 8	360	45	40,20	62,00	105,40	180,30
384 GLD 8	384	48	42,80	66,30	112,10	192,10
408 GLD 8	408	51	45,90	70,60	119,60	206,40
416 GLD 8	416	52	46,90	72,10	122,20	210,80
456 GLD 8	456	57	52,10	79,90	135,10	233,00
480 GLD 8	480	60	54,50	84,20	142,50	245,40
536 GLD 8	536	67	58,90	89,90	150,60	260,90
544 GLD 8	544	68	62,00	94,20	158,60	273,90
560 GLD 8	560	70	62,60	95,40	161,70	276,40
600 GLD 8	600	75	65,10	97,90	165,50	285,10
608 GLD 8	608	76	65,70	99,20	167,90	288,70
632 GLD 8	632	79	66,30	99,70	171,00	294,40
640 GLD 8	640	80	68,20	102,80	174,80	300,60
680 GLD 8	680	85	69,40	105,40	179,10	307,30
720 GLD 8	720	90	73,70	111,50	189,00	325,90
800 GLD 8	800	100	78,00	119,60	203,30	349,50
840 GLD 8	840	105	81,10	123,40	208,80	358,20
880 GLD 8	880	110	83,00	126,50	213,20	368,70
896 GLD 8	896	112	83,70	127,00	216,30	371,80
920 GLD 8	920	115	86,10	130,80	221,90	381,70
960 GLD 8	960	120	89,20	135,10	229,30	394,10
1000 GLD 8	1000	125	92,30	138,80	236,00	406,50
1040 GLD 8	1040	130	96,10	144,40	245,40	422,60
1080 GLD 8	1080	135	98,60	148,70	253,50	435,70
1120 GLD 8	1120	140	101,00	153,70	260,90	447,40
1200 GLD 8	1200	150	107,20	161,70	273,90	470,40
1224 GLD 8	1224	153	109,00	164,80	279,50	479,70
1280 GLD 8	1280	160	112,80	171,00	288,70	496,40
1352 GLD 8	1352	169	114,60	174,10	294,90	506,90
1424 GLD 8	1424	178	120,60	183,70	311,20	533,30
1440 GLD 8	1440	180	122,00	185,90	314,80	539,10
1464 GLD 8	1464	183	127,60	193,90	327,20	563,30
1600 GLD 8	1600	200	133,20	200,80	341,40	585,60
1680 GLD 8	1680	210	138,20	209,50	355,00	609,50
1760 GLD 8	1760	220	143,20	218,10	368,70	633,30
1800 GLD 8	1800	225	146,30	221,90	376,70	647,00
2000 GLD 8	2000	250	161,70	244,80	413,30	711,40
2200 GLD 8	2200	275	175,30	265,20	449,30	773,40
2272 GLD 8	2272	284	180,50	273,00	462,20	795,50
2400 GLD 8	2400	300	189,60	286,90	485,20	834,70
2520 GLD 8	2520	315	194,60	294,90	499,50	856,40
2600 GLD 8	2600	325	200,80	304,20	515,60	883,60
2800 GLD 8	2800	350	216,90	327,20	555,30	956,10
3048 GLD 8	3048	381	253,50	386,00	648,10	1111,10
3280 GLD 8	3280	410	272,60	414,60	695,90	1196,60
3600 GLD 8	3600	450	299,30	454,20	766,50	1311,20
4400 GLD 8	4400	550	365,00	555,30	937,50	1604,90

Verfügbarkeit und Wickelpreise auf Anfrage.

Availability and prices of sleeves on request.

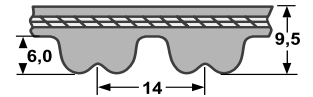

**Type GLD 14 - Teilung/ Pitch 14 mm**

Größe size	Wirklänge pitch length mm	Zähnezahl number of teeth	Breite width	Breite width	Breite width	Breite width	Breite width
			40 mm	55 mm	85 mm	115 mm	170 mm
			Stück/ piece Euro	Stück/ piece Euro	Stück/ piece Euro	Stück/ piece Euro	Stück/ piece Euro
966 GLD 14	966	69	423,30	595,50	974,10	1266,60	1875,80
994 GLD 14	994	71	435,70	599,30	981,70	1269,70	1880,70
1092 GLD 14	1092	78	440,50	602,40	989,60	1274,70	1890,00
1106 GLD 14	1106	79	446,70	610,30	1002,70	1291,40	1914,20
1190 GLD 14	1190	85	469,20	641,90	1006,40	1355,90	2011,40
1260 GLD 14	1260	90	471,60	645,00	1010,60	1361,50	2019,60
1288 GLD 14	1288	92	476,60	651,90	1021,90	1376,30	2041,80
1344 GLD 14	1344	96	480,20	674,20	1066,40	1436,30	2131,10
1400 GLD 14	1400	100	500,10	702,10	1099,90	1479,20	2194,90
1442 GLD 14	1442	103	515,30	723,20	1132,80	1523,80	2260,60
1568 GLD 14	1568	112	531,10	746,70	1161,30	1559,00	2301,10
1610 GLD 14	1610	115	545,30	766,50	1192,20	1600,60	2362,80
1750 GLD 14	1750	125	580,80	812,10	1250,80	1699,80	2511,50
1764 GLD 14	1764	126	584,40	816,70	1256,70	1709,70	2526,40
1778 GLD 14	1778	127	589,90	826,00	1266,60	1722,10	2546,90
1848 GLD 14	1848	132	593,10	838,40	1282,10	1746,90	2578,40
1890 GLD 14	1890	135	606,70	857,00	1311,20	1786,60	2636,70
1904 GLD 14	1904	136	607,20	863,20	1321,10	1800,10	2656,60
1960 GLD 14	1960	140	607,90	868,80	1327,30	1852,90	2734,60
2100 GLD 14	2100	150	749,00	1054,60	1634,80	2192,80	3238,30
2240 GLD 14	2240	160	776,00	1086,00	1649,70	2258,90	3349,40
2310 GLD 14	2310	165	800,20	1120,30	1701,10	2329,60	3454,20
2380 GLD 14	2380	170	811,70	1131,70	1755,90	2369,50	3502,90
2450 GLD 14	2450	175	835,80	1157,30	1807,20	2439,30	3605,90
2590 GLD 14	2590	185	850,10	1189,40	1858,50	2512,70	3719,90
2660 GLD 14	2660	190	875,10	1221,40	1951,90	2547,70	3762,00
2800 GLD 14	2800	200	921,40	1285,60	2054,50	2681,60	3960,10
2968 GLD 14	2968	212	945,00	1333,80	2079,50	2766,40	4087,00
3150 GLD 14	3150	225	970,60	1386,00	2106,50	2858,30	4224,40
3360 GLD 14	3360	240	1039,80	1477,20	2245,40	3051,50	4503,10
3500 GLD 14	3500	250	1058,90	1490,10	2318,20	3118,40	4610,70
3850 GLD 14	3850	275	1163,70	1617,00	2512,70	3384,30	4994,80
3920 GLD 14	3920	280	1185,10	1622,70	2558,30	3445,90	5128,80
4326 GLD 14	4326	309	1287,00	1790,90	2757,20	3736,30	5659,70
4578 GLD 14	4578	327	1339,10	1875,70	2893,20	3913,00	5783,70
4956 GLD 14	4956	354	1433,80	2004,50	3115,70	4162,40	6245,50
Verfügbarkeit und Wickelpreise auf Anfrage.							
Availability and prices of sleeves on request.							

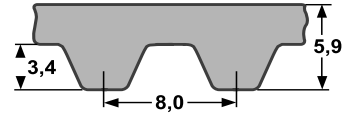

### Type PC - 8MGT - Teilung/ Pitch 8 mm

Größe size	Wirklänge pitch length mm	Zähnezahl number of teeth	Breite width	Breite width	Breite width	Breite width
			12 mm Stück piece Euro	21 mm Stück piece Euro	36 mm Stück piece Euro	62 mm Stück piece Euro
PC-8MGT - 640	640	80	62,30	109,10	186,90	321,90
PC-8MGT - 720	720	90	64,00	112,10	192,20	330,90
PC-8MGT - 800	800	100	65,90	115,30	197,80	340,60
PC-8MGT - 896	896	112	68,10	119,40	204,50	352,30
PC-8MGT - 960	960	120	68,30	121,90	208,90	359,80
PC-8MGT - 1000	1000	125	68,40	123,40	211,60	364,40
PC-8MGT - 1040	1040	130	70,40	125,70	215,50	371,10
PC-8MGT - 1120	1120	140	74,50	130,20	223,20	384,60
PC-8MGT - 1200	1200	150	79,40	138,80	238,10	409,90
PC-8MGT - 1224	1224	153	80,60	141,00	241,80	416,40
PC-8MGT - 1280	1280	160	83,50	146,30	250,50	431,50
PC-8MGT - 1440	1440	180	90,20	157,90	270,50	465,80
PC-8MGT - 1600	1600	200	97,20	170,10	291,80	502,50
PC-8MGT - 1760	1760	220	105,60	184,90	317,00	545,90
PC-8MGT - 1792	1792	224	107,30	187,90	322,00	554,60
PC-8MGT - 2000	2000	250	117,50	205,60	352,50	607,10
PC-8MGT - 2200	2200	275	126,90	219,80	376,80	648,90
PC-8MGT - 2240	2240	280	128,80	222,60	381,70	657,30
PC-8MGT - 2400	2400	300	133,70	233,90	401,10	690,90
PC-8MGT - 2520	2520	315	138,60	242,50	415,80	716,00
PC-8MGT - 2600	2600	325	141,80	248,20	425,60	732,80
PC-8MGT - 2800	2800	350	150,00	262,40	449,90	774,80
PC-8MGT - 2840	2840	355	151,60	265,20	454,80	783,20
PC-8MGT - 3048	3048	381	160,00	280,00	480,20	826,80
PC-8MGT - 3200	3200	400	166,20	290,80	498,70	858,60
PC-8MGT - 3280	3580	410	181,70	317,90	544,80	938,30
PC-8MGT - 3600	3600	450	182,50	319,30	547,20	942,50
PC-8MGT - 4000	4000	500	198,50	347,70	595,80	1026,40
PC-8MGT - 4400	4400	550	214,80	376,00	644,50	1110,20
PC-8MGT - 4480	4480	560	218,10	381,70	654,30	1127,00

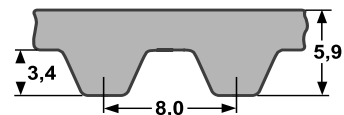

### Type PC - 8M - Teilung/ Pitch 8 mm

Größe size	Wirklänge pitch length mm	Zähnezahl number of teeth	Breite width	Breite width	Breite width
			12 mm Stück piece Euro	21 mm Stück piece Euro	36 mm Stück piece Euro
PC-8M - 248	248	31	34,30	59,80	102,50
PC-8M - 288	288	36	36,10	63,20	108,30
PC-8M - 352	352	44	39,50	69,20	118,20
PC-8M - 416	416	52	42,70	74,70	128,10
PC-8M - 456	456	57	44,90	78,50	134,20
PC-8M - 480	480	60	45,90	80,30	137,90
PC-8M - 544	544	68	49,30	86,20	147,70
PC-8M - 608	608	76	52,50	91,90	157,40



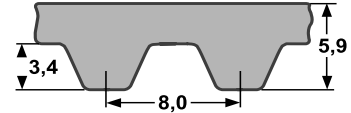

### Type Falcon - 8GTR - Teilung/ Pitch 8 mm

Größe size	Wirklänge pitch length mm	Zähnezahl number of teeth	Breite width		Breite width		Breite width	
			12 mm Stück piece Euro	21 mm Stück piece Euro	36 mm Stück piece Euro	62 mm Stück piece Euro		
8GTR-640	640	80	62,30	109,10	186,90	321,90		
8GTR-720	720	90	64,00	112,10	192,20	330,90		
8GTR-800	800	100	65,90	115,30	197,80	340,60		
8GTR-896	896	112	68,10	119,40	204,50	352,30		
8GTR-1000	1000	125	68,40	123,40	211,60	364,40		
8GTR-1120	1120	140	74,50	130,20	223,20	384,60		
8GTR-1200	1200	150	79,40	138,80	238,10	409,90		
8GTR-1280	1280	160	83,50	146,30	250,50	431,50		
8GTR-1440	1440	180	90,20	157,90	270,50	465,80		
8GTR-1600	1600	200	97,20	170,10	291,80	502,50		
8GTR-1792	1792	224	107,30	187,90	322,00	554,60		
8GTR-2000	2000	250	117,50	205,60	352,50	607,10		
8GTR-2240	2240	280	128,80	222,60	381,70	657,30		
8GTR-2400	2400	300	133,70	233,90	401,10	690,90		
8GTR-2520	2520	315	138,60	242,50	415,80	716,00		
8GTR-2840	2840	355	151,60	265,20	454,80	783,20		
8GTR-3200	3200	400	166,20	290,80	498,70	858,60		
8GTR-3600	3600	450	182,50	319,30	547,20	942,50		
8GTR-4000	4000	500	198,50	347,70	595,80	1026,40		
8GTR-4480	4480	560	218,10	381,70	654,30	1127,00		

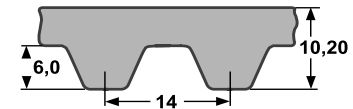

### Type Falcon - 14GTR - Teilung/ Pitch 14 mm

Größe size	Wirklänge pitch length mm	Zähnezahl number of teeth	Breite width		Breite width		Breite width	
			20 mm Stück piece Euro	37 mm Stück piece Euro	68 mm Stück piece Euro	90 mm Stück piece Euro	125 mm Stück piece Euro	
14GTR-994	994	71	213,80	395,60	727,10	962,30	1336,50	
14GTR-1120	1120	80	233,60	432,00	794,10	1051,10	1459,80	
14GTR-1190	1190	85	244,50	452,40	831,40	1100,40	1528,30	
14GTR-1260	1260	90	255,60	472,70	868,60	1149,70	1596,70	
14GTR-1400	1400	100	277,40	513,20	943,20	1248,30	1733,70	
14GTR-1568	1568	112	303,70	561,80	1032,50	1366,60	1760,10	
14GTR-1750	1750	125	332,30	614,50	1129,30	1494,70	2076,10	
14GTR-1890	1890	135	347,00	658,00	1217,90	1594,00	2212,20	
14GTR-1960	1960	140	365,00	675,30	1241,20	1642,70	2281,60	
14GTR-2100	2100	150	387,00	715,90	1315,70	1741,20	2418,40	
14GTR-2240	2240	160	408,80	756,40	1390,10	1839,80	2555,40	
14GTR-2380	2380	170	430,80	796,90	1464,70	1938,60	2692,30	
14GTR-2520	2520	180	452,60	837,50	1539,00	2037,20	2829,20	
14GTR-2660	2660	190	474,60	878,00	1613,70	2135,70	2966,20	
14GTR-2800	2800	200	496,60	918,50	1688,20	2234,30	3103,20	
14GTR-3136	3136	224	549,00	1015,90	1866,90	2470,90	3431,80	
14GTR-3304	3304	236	575,40	1064,50	1956,20	2589,10	3596,10	
14GTR-3500	3500	250	606,00	1121,20	2062,70	2727,30	3787,90	
14GTR-3920	3920	280	671,80	1242,80	2284,10	3023,00	4198,70	
14GTR-4410	4410	315	748,50	1384,60	2544,80	3368,10	4678,00	

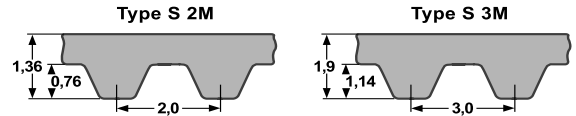

Type S 2 M - Teilung/ Pitch 2 mm		Type S 3 M - Teilung/ Pitch 3 mm	
Bezeichnung designation Wirklänge / mm pitch length / mm	Bezeichnung designation Wirklänge / mm pitch length / mm	Bezeichnung designation Wirklänge / mm pitch length / mm	Bezeichnung designation Wirklänge / mm pitch length / mm
S 2M 90 G	S 2M 334 PU-K	S 3M 120 PU-K	S 3M 459 PU-K/G
S 2M 92 G	S 2M 340 PU-K/G	S 3M 129 G	S 3M 468 G
S 2M 100 PU-K/G	S 2M 344 G	S 3M 144 PU-K/G	S 3M 480 G
S 2M 102 G	S 2M 354 PU-K	S 3M 150 PU-K/G	S 3M 486 PU-K/G
S 2M 112 PU-K	S 2M 360 PU-K	S 3M 159 PU-K	S 3M 489 G
S 2M 114 G	S 2M 364 G	S 3M 162 G	S 3M 501 PU-K/G
S 2M 116 PU-K/G	S 2M 370 PU-K/G	S 3M 168 G	S 3M 504 PU-K
S 2M 120 PU-K/G	S 2M 380 PU-K/G	S 3M 171 G	S 3M 507 PU-K
S 2M 122 PU-K/G	S 2M 386 G	S 3M 174 PU-K	S 3M 516 G
S 2M 126 PU-K/G	S 2M 396 G	S 3M 177 PU-K/G	S 3M 519 G
S 2M 128 G	S 2M 400 PU-K/G	S 3M 180 G	S 3M 525 G
S 2M 134 G	S 2M 408 G	S 3M 186 G	S 3M 537 PU-K/G
S 2M 138 PU-K	S 2M 420 G	S 3M 192 PU-K/G	S 3M 540 G
S 2M 140 PU-K/G	S 2M 436 PU-K	S 3M 195 PU-K	S 3M 549 G
S 2M 142 PU-K/G	S 2M 438 G	S 3M 201 PU-K/G	S 3M 564 PU-K/G
S 2M 144 PU-K/G	S 2M 440 PU-K	S 3M 204 PU-K	S 3M 588 PU-K/G
S 2M 148 PU-K	S 2M 448 PU-K/G	S 3M 207 G	S 3M 597 G
S 2M 150 G	S 2M 452 G	S 3M 210 PU-K/G	S 3M 600 PU-K/G
S 2M 158 PU-K/G	S 2M 454 PU-K	S 3M 213 PU-K	S 3M 609 PU-K/G
S 2M 160 PU-K/G	S 2M 460 PU-K	S 3M 219 PU-K/G	S 3M 633 PU-K/G
S 2M 164 PU-K/G	S 2M 474 G	S 3M 225 PU-K/G	S 3M 657 G
S 2M 166 PU-K/G	S 2M 480 PU-K	S 3M 228 G	S 3M 660 PU-K/G
S 2M 168 G	S 2M 488 PU-K	S 3M 234 PU-K/G	S 3M 666 PU-K
S 2M 170 PU-K/G	S 2M 490 G	S 3M 237 G	S 3M 681 PU-K/G
S 2M 172 PU-K/G	S 2M 494 PU-K	S 3M 240 PU-K	S 3M 699 PU-K/G
S 2M 176 G	S 2M 500 PU-K/G	S 3M 243 G	S 3M 735 G
S 2M 180 PU-K/G	S 2M 504 PU-K	S 3M 246 PU-K	S 3M 750 PU-K
S 2M 184 PU-K/G	S 2M 520 PU-K/G	S 3M 252 PU-K/G	S 3M 765 PU-K
S 2M 186 G	S 2M 530	S 3M 255 PU-K/G	S 3M 774 PU-K
S 2M 190 PU-K/G	S 2M 540 G	S 3M 258 G	S 3M 789 PU-K/G
S 2M 192 G	S 2M 560 PU-K/G	S 3M 264 PU-K/G	S 3M 804 PU-K
S 2M 198 G	S 2M 580 PU-K	S 3M 267 PU-K	S 3M 810 PU-K/G
S 2M 200 PU-K/G	S 2M 594 G	S 3M 270 PU-K	S 3M 852 G
S 2M 202 G	S 2M 596 G	S 3M 276 PU-K/G	S 3M 882 G
S 2M 210 G	S 2M 600 PU-K/G	S 3M 285 PU-K/G	S 3M 885 G
S 2M 214 PU-K/G	S 2M 630 PU-K/G	S 3M 288 G	S 3M 900 PU-K/G
S 2M 216 G	S 2M 656 G	S 3M 300 PU-K/G	S 3M 918 G
S 2M 220 PU-K/G	S 2M 710 PU-K/G	S 3M 303 G	S 3M 927 G
S 2M 222 G	S 2M 752 G	S 3M 309 G	S 3M 936 G
S 2M 224 PU-K/G	S 2M 754 PU-K/G	S 3M 312 PU-K/G	S 3M 990 G
S 2M 230 PU-K/G	S 2M 790 PU-K	S 3M 318 PU-K/G	S 3M 1005 PU-K
S 2M 234 PU-K/G	S 2M 796 G	S 3M 327 PU-K/G	S 3M 1050 PU-K
S 2M 236 PU-K	S 2M 800 PU-K/G	S 3M 330 G	S 3M 1146 G
S 2M 240 PU-K/G	S 2M 806 PU-K	S 3M 339 PU-K/G	S 3M 1188 G
S 2M 250 PU-K/G	S 2M 900 PU-K/G	S 3M 342 PU-K	S 3M 1260 PU-K
S 2M 258 PU-K	S 2M 940 G	S 3M 354 PU-K	S 3M 1299 G
S 2M 260 PU-K/G	S 2M 946 G	S 3M 360 PU-K/G	S 3M 1596 PU-K
S 2M 262 G	S 2M 950 G	S 3M 363 G	S 3M 1800 PU-K
S 2M 266 PU-K/G	S 2M 976 PU-K	S 3M 366 G	S 3M 2082 G
S 2M 274 G	S 2M 984 G	S 3M 372 G	S 3M 2100 PU-K
S 2M 280 PU-K/G	S 2M 1000 PU-K	S 3M 378 G	
S 2M 288 G	S 2M 1036 G	S 3M 384 PU-K/G	
S 2M 290 G	S 2M 1074 G	S 3M 387 G	
S 2M 292 G	S 2M 1110 G	S 3M 396 PU-K	
S 2M 296 PU-K/G	S 2M 1136 G	S 3M 399 G	
S 2M 300 PU-K/G	S 2M 1154 G	S 3M 402 PU-K/G	
S 2M 308 G	S 2M 1166 G	S 3M 405 PU-K/G	Preise auf Anfrage.
S 2M 314 PU-K	S 2M 1224 G	S 3M 417 PU-K	Prices on request.
S 2M 316 G	S 2M 1228 G	S 3M 420 PU-K/G	
S 2M 320 PU-K/G		S 3M 423 G	
S 2M 322 G		S 3M 432 PU-K	
S 2M 324 G		S 3M 447 PU-K	
S 2M 328 G		S 3M 453 PU-K/G	

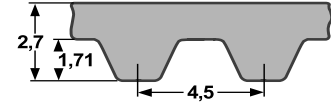

### Type S 4,5 M - Teilung/ Pitch 4,5 mm

Bezeichnung type	Zähnezahl number of teeth	Breite/width 9 mm Code - No. 090 Stück/piece Euro	Breite/width 15 mm Code -No. 150 Stück/piece Euro	Breite/width 25 mm Code -No. 250 Stück/piece Euro
S 4,5 M 162	36	3,40	4,80	6,90
S 4,5 M 180	40	3,80	5,20	7,30
S 4,5 M 198	44	3,80	5,40	7,70
S 4,5 M 203	45	3,90	5,40	8,00
S 4,5 M 225	50	4,00	5,70	8,40
S 4,5 M 239	53	4,10	6,10	8,80
S 4,5 M 252	56	4,20	6,40	9,40
S 4,5 M 257	57	4,30	6,50	9,50
S 4,5 M 275	61	4,50	6,90	9,80
S 4,5 M 279	62	4,50	6,90	9,90
S 4,5 M 284	63	4,60	7,00	10,10
S 4,5 M 293	65	4,60	7,10	10,20
S 4,5 M 297	66	4,60	7,10	10,30
S 4,5 M 315	70	4,80	7,20	10,30
S 4,5 M 324	72	4,80	7,20	10,50
S 4,5 M 329	73	4,80	7,20	10,70
S 4,5 M 333	74	4,80	7,30	10,80
S 4,5 M 338	75	4,80	7,30	10,80
S 4,5 M 347	77	5,10	7,40	10,90
S 4,5 M 351	78	5,10	7,40	10,90
S 4,5 M 360	80	5,10	7,40	11,10
S 4,5 M 369	82	5,10	7,40	11,10
S 4,5 M 383	85	5,20	7,50	11,30
S 4,5 M 387	86	5,20	7,50	11,40
S 4,5 M 396	88	5,30	7,50	11,50
S 4,5 M 414	92	5,40	8,00	12,20
S 4,5 M 437	97	5,70	8,70	12,80
S 4,5 M 441	98	5,90	8,70	13,00
S 4,5 M 450	100	6,10	9,00	13,40
S 4,5 M 454	103	6,30	9,30	13,50
S 4,5 M 468	104	6,30	9,30	13,50
S 4,5 M 482	107	6,30	9,30	13,60
S 4,5 M 486	108	6,30	9,30	13,60
S 4,5 M 491	109	6,40	9,40	13,70
S 4,5 M 500	111	6,40	9,50	13,80
S 4,5 M 504	112	6,50	9,50	13,90
S 4,5 M 513	114	6,50	9,60	14,00
S 4,5 M 518	115	6,50	9,60	14,20
S 4,5 M 558	124	6,60	9,90	14,90
S 4,5 M 563	125	6,60	9,90	14,90
S 4,5 M 567	126	6,90	9,90	15,00
S 4,5 M 612	136	7,10	10,20	15,60
S 4,5 M 617	137	7,10	10,30	15,70
S 4,5 M 630	140	7,20	10,70	16,10
S 4,5 M 653	145	7,30	10,90	16,30
S 4,5 M 675	150	7,40	11,10	16,60
S 4,5 M 711	158	7,50	11,30	16,80
S 4,5 M 729	162	7,70	11,40	16,90
S 4,5 M 738	164	7,70	11,50	17,10
S 4,5 M 801	178	8,10	12,30	18,40
S 4,5 M 864	192	8,80	12,70	18,70
S 4,5 M 905	201	9,30	12,90	19,00
S 4,5 M 932	207	9,50	13,20	19,20
S 4,5 M 950	211	9,60	13,50	19,60
S 4,5 M 1031	229	9,90	14,00	20,90
S 4,5 M 1350	300	13,20	18,50	27,30
S 4,5 M 2111	469	17,60	26,20	38,60

Wickelpreise und weitere Abmessungen auf Anfrage.

Prices of sleeves and further dimensions on request.

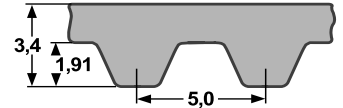

### Type S 5 M - Teilung/Pitch 5 mm

Bezeichnung type	Zähnezahl number of teeth	Breite/width 9 mm Code - No. 090 Stück/piece Euro	Breite/width 15 mm Code -No. 150 Stück/piece Euro	Breite/width 25 mm Code -No. 250 Stück/piece Euro
Wirklänge / mm pitch length / mm				
S 5 M 225	45	4,30	6,60	9,50
S 5 M 230	46	4,40	6,70	9,60
S 5 M 255	51	4,60	7,20	10,30
S 5 M 260	52	5,10	7,30	10,90
S 5 M 275	55	5,20	7,50	11,20
S 5 M 285	57	5,20	7,50	11,30
S 5 M 295	59	5,20	7,50	11,40
S 5 M 300	60	5,30	7,70	11,40
S 5 M 305	61	5,30	7,80	11,50
S 5 M 320	64	5,40	8,10	11,70
S 5 M 325	65	5,40	8,10	11,70
S 5 M 350	70	5,60	8,20	12,00
S 5 M 375	75	5,60	8,30	12,40
S 5 M 380	76	5,60	8,30	12,50
S 5 M 390	78	5,70	8,40	12,70
S 5 M 400	80	5,90	8,50	12,80
S 5 M 410	82	6,00	8,50	12,90
S 5 M 420	84	6,10	8,70	13,00
S 5 M 425	85	6,10	8,70	13,00
S 5 M 435	87	6,50	9,40	13,90
S 5 M 440	88	6,60	9,50	14,20
S 5 M 445	89	6,70	9,70	14,50
S 5 M 450	90	6,90	9,80	14,80
S 5 M 475	95	7,10	10,20	15,00
S 5 M 490	98	7,10	10,30	15,30
S 5 M 500	100	7,20	10,50	15,50
S 5 M 520	104	7,30	10,80	15,70
S 5 M 525	105	7,30	10,80	15,70
S 5 M 550	110	7,30	10,90	16,30
S 5 M 560	112	7,30	11,10	16,60
S 5 M 565	113	7,30	11,10	16,60
S 5 M 570	114	7,40	11,20	16,70
S 5 M 575	115	7,40	11,20	16,70
S 5 M 590	118	7,50	11,40	16,90
S 5 M 600	120	7,50	11,50	17,10
S 5 M 625	125	7,80	11,70	17,60
S 5 M 635	127	8,00	11,70	17,80
S 5 M 645	129	8,10	12,00	18,10
S 5 M 650	130	8,10	12,00	18,10
S 5 M 665	133	8,20	12,30	18,10
S 5 M 670	134	8,20	12,30	18,10
S 5 M 675	135	8,30	12,40	18,40
S 5 M 690	138	8,30	12,40	18,50
S 5 M 695	139	8,40	12,40	18,60
S 5 M 700	140	8,40	12,40	18,60
S 5 M 710	142	8,40	12,60	18,70
S 5 M 725	145	8,40	12,70	18,70
S 5 M 730	146	8,40	12,70	18,70
S 5 M 740	148	8,50	12,80	18,90
S 5 M 750	150	8,50	12,90	19,10
S 5 M 765	153	8,70	13,20	19,50
S 5 M 770	154	8,80	13,40	19,60
S 5 M 775	155	8,80	13,40	19,60
S 5 M 780	156	8,80	13,50	19,70
S 5 M 800	160	9,20	13,70	20,30
S 5 M 810	162	9,20	13,80	20,70
S 5 M 830	166	9,30	13,80	20,80
S 5 M 845	169	9,30	13,90	20,90
S 5 M 850	170	9,40	13,90	21,00
S 5 M 860	172	9,50	13,90	21,10
S 5 M 870	174	9,50	14,20	21,20
S 5 M 900	180	9,60	14,30	21,30
S 5 M 920	184	9,80	14,50	21,60

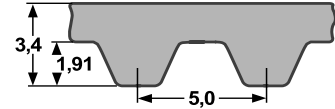

### Type S 5 M - Teilung/Pitch 5 mm

Bezeichnung type  Wirklänge / mm pitch length / mm	Zähnezahl number of teeth	Breite/width 9 mm Code - No. 090 Stück/piece Euro	Breite/width 15 mm Code -No. 150 Stück/piece Euro	Breite/width 25 mm Code -No. 250 Stück/piece Euro
S 5 M 940	188	9,90	14,60	21,80
S 5 M 950	190	9,90	14,80	21,90
S 5 M 965	193	10,10	14,90	22,20
S 5 M 975	195	10,20	15,30	22,40
S 5 M 1000	200	10,30	15,40	22,80
S 5 M 1025	205	10,50	15,60	23,10
S 5 M 1050	210	10,70	15,70	23,40
S 5 M 1055	211	10,70	15,70	23,40
S 5 M 1085	217	10,90	16,10	23,90
S 5 M 1105	221	11,10	16,50	24,20
S 5 M 1115	223	11,10	16,50	24,30
S 5 M 1120	224	11,20	16,60	24,50
S 5 M 1125	225	11,20	16,60	24,70
S 5 M 1135	227	11,30	16,70	24,90
S 5 M 1145	229	11,40	16,80	25,00
S 5 M 1160	232	11,50	16,90	25,30
S 5 M 1165	233	11,50	16,90	25,30
S 5 M 1195	239	11,60	17,20	25,60
S 5 M 1225	245	11,70	17,50	26,10
S 5 M 1250	250	11,90	17,60	26,40
S 5 M 1260	252	12,00	17,80	26,60
S 5 M 1270	254	12,00	17,80	26,60
S 5 M 1295	259	12,30	18,10	27,20
S 5 M 1350	270	12,60	18,70	27,90
S 5 M 1420	284	13,00	19,50	28,90
S 5 M 1500	300	13,80	20,60	30,40
S 5 M 1505	301	13,80	20,70	30,60
S 5 M 1530	306	14,00	21,00	31,00
S 5 M 1595	319	14,80	21,90	32,40
S 5 M 1605	321	14,80	21,90	32,60
S 5 M 1715	343	15,80	22,50	34,50
S 5 M 1800	360	16,60	24,80	36,50
S 5 M 2000	400	18,50	27,40	40,60
S 5 M 2145	429	19,70	29,40	43,60
S 5 M 2255	451	20,80	30,80	45,90
S 5 M 2300	460	21,10	31,50	46,80
S 5 M 2525	505	23,30	34,60	51,30

Wickelpreise und weitere Abmessungen auf Anfrage.

Prices of sleeves and further dimensions on request.

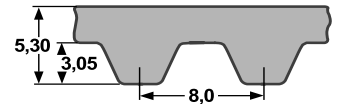

**Type S 8 M - Teilung/Pitch 8 mm**

Bezeichnung type	Zähnezahl number of teeth	Breite/width 20 mm Code - No. 200 Stück/piece Euro	Breite/width 30 mm Code - No. 300 Stück/piece Euro	Breite/width 50 mm Code - No. 500 Stück/piece Euro	Breite/width 85 mm Code - No. 850 Stück/piece Euro
Wirklänge / mm pitch length / mm					
S 8 M 352	44	9,90	14,80	25,30	43,30
S 8 M 376	47	10,50	15,70	26,40	45,10
S 8 M 384	48	10,80	16,10	26,90	46,20
S 8 M 400	50	11,10	16,60	27,50	47,00
S 8 M 408	51	11,20	16,70	27,80	47,40
S 8 M 424	53	11,40	17,00	28,30	48,20
S 8 M 440	55	11,60	17,20	28,70	48,90
S 8 M 456	57	11,70	17,70	29,30	49,90
S 8 M 480	60	12,00	18,00	30,10	51,20
S 8 M 496	62	12,40	18,70	31,00	52,50
S 8 M 512	64	12,90	19,30	32,10	53,90
S 8 M 520	65	13,00	19,60	32,40	54,40
S 8 M 528	66	13,20	19,80	32,70	55,00
S 8 M 560	70	13,70	20,50	33,90	57,30
S 8 M 584	73	13,90	20,80	34,50	58,60
S 8 M 600	75	14,00	21,00	34,80	59,70
S 8 M 632	79	14,80	21,90	36,40	62,50
S 8 M 640	80	14,90	22,00	36,70	63,50
S 8 M 656	82	15,40	23,10	38,00	65,30
S 8 M 672	84	15,50	23,20	38,50	65,80
S 8 M 680	85	15,60	23,30	38,70	66,00
S 8 M 712	89	16,00	23,70	39,80	67,00
S 8 M 720	90	16,00	23,80	39,90	67,20
S 8 M 728	91	16,30	23,90	40,20	68,00
S 8 M 760	95	16,80	24,80	41,70	70,60
S 8 M 800	100	17,00	25,60	42,80	73,40
S 8 M 824	103	17,50	26,20	43,40	74,30
S 8 M 840	105	17,70	26,40	43,80	75,00
S 8 M 848	106	17,80	26,50	44,10	75,90
S 8 M 880	110	18,10	27,00	44,90	76,40
S 8 M 888	111	18,40	27,30	45,40	76,90
S 8 M 896	112	18,60	27,50	45,80	77,60
S 8 M 920	115	19,10	28,30	47,10	79,60
S 8 M 944	118	19,30	28,70	47,80	81,10
S 8 M 960	120	19,50	29,00	48,20	82,50
S 8 M 976	122	19,80	29,40	49,20	83,50
S 8 M 984	123	19,80	29,40	49,30	83,60
S 8 M 1000	125	20,30	30,10	50,10	84,90
S 8 M 1032	129	20,80	30,70	51,30	86,80
S 8 M 1040	130	20,90	31,00	51,50	87,20
S 8 M 1056	132	21,10	31,50	52,50	89,20
S 8 M 1080	135	21,30	32,10	53,30	90,10
S 8 M 1096	137	21,70	32,30	53,70	90,50
S 8 M 1120	140	21,90	32,80	54,30	93,50
S 8 M 1128	141	22,00	32,90	54,50	93,70
S 8 M 1136	142	22,00	32,90	54,70	94,10
S 8 M 1152	144	22,40	33,30	55,80	94,80
S 8 M 1160	145	22,40	33,50	56,30	95,50
S 8 M 1184	148	22,90	34,30	56,90	96,80
S 8 M 1192	149	23,10	34,40	57,00	97,40
S 8 M 1200	150	23,20	34,60	57,30	97,80
S 8 M 1216	152	23,40	34,90	57,70	98,30
S 8 M 1224	153	23,50	35,20	58,60	99,30
S 8 M 1240	155	23,90	35,70	59,70	100,70
S 8 M 1248	156	24,00	35,90	60,00	101,60
S 8 M 1256	157	24,20	36,10	60,20	102,50
S 8 M 1272	159	24,40	36,30	60,50	103,20
S 8 M 1280	160	24,50	36,40	60,60	103,50
S 8 M 1296	162	25,00	36,80	61,80	104,60
S 8 M 1304	163	25,20	37,10	62,50	105,90
S 8 M 1312	164	25,20	37,30	62,80	106,20
S 8 M 1320	165	25,30	37,40	63,00	106,60
S 8 M 1344	168	25,50	37,90	63,90	107,60
S 8 M 1352	169	25,50	38,00	64,10	108,00

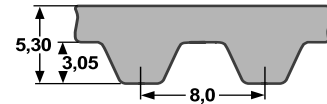

### Type S 8 M - Teilung/Pitch 8 mm

Bezeichnung type	Zähnezahl number of teeth	Breite/width 20 mm Code - No. 200 Stück/piece Euro	Breite/width 30 mm Code - No. 300 Stück/piece Euro	Breite/width 50 mm Code - No. 500 Stück/piece Euro	Breite/width 85 mm Code - No. 850 Stück/piece Euro
Wirklänge / mm pitch length / mm					
S 8 M 1360	170	25,60	38,40	64,30	108,30
S 8 M 1384	173	25,90	38,70	65,30	109,80
S 8 M 1392	174	26,10	38,80	65,40	110,10
S 8 M 1400	175	26,20	39,00	65,60	110,50
S 8 M 1424	178	26,40	39,40	65,80	112,10
S 8 M 1440	180	26,50	39,60	66,30	112,50
S 8 M 1480	185	27,20	40,30	67,20	115,10
S 8 M 1520	190	27,60	41,20	68,10	117,30
S 8 M 1552	194	28,10	41,90	69,50	118,90
S 8 M 1600	200	28,90	42,90	71,50	121,20
S 8 M 1648	206	29,40	43,20	73,60	124,40
S 8 M 1680	210	30,20	44,60	74,80	126,40
S 8 M 1696	212	30,30	44,90	75,40	127,20
S 8 M 1728	216	30,60	45,70	76,40	129,50
S 8 M 1760	220	31,10	46,30	77,20	131,70
S 8 M 1776	222	31,20	46,80	77,60	132,80
S 8 M 1800	225	31,60	47,40	78,30	134,10
S 8 M 1808	226	31,80	47,50	78,60	134,70
S 8 M 1832	229	32,20	48,10	79,60	136,10
S 8 M 1880	235	32,60	48,40	81,00	138,80
S 8 M 1912	239	33,30	57,90	82,50	141,10
S 8 M 1952	244	34,00	54,50	84,50	144,40
S 8 M 2000	250	34,80	50,50	86,80	148,40
S 8 M 2040	255	35,50	51,50	88,20	150,50
S 8 M 2048	256	35,70	51,70	88,50	150,90
S 8 M 2120	265	36,50	52,70	90,80	154,90
S 8 M 2160	270	37,30	55,20	92,20	157,20
S 8 M 2240	280	38,40	57,30	94,80	161,70
S 8 M 2272	284	38,80	57,70	96,00	163,20
S 8 M 2304	288	39,90	58,50	97,50	165,40
S 8 M 2400	300	40,80	61,10	102,00	172,10
S 8 M 2496	312	42,30	63,10	105,50	178,40
S 8 M 2560	320	43,70	64,40	107,70	182,50
S 8 M 2600	325	44,00	65,30	108,70	185,10
S 8 M 2800	350	46,90	68,10	116,40	198,40
S 8 M 2880	360	48,20	70,10	119,70	204,20
S 8 M 2944	368	49,30	71,70	122,50	208,80
S 8 M 3200	400	53,80	77,90	133,50	227,20
S 8 M 3272	409	54,90	79,70	136,50	232,40
S 8 M 3600	450	60,50	87,80	150,20	255,60
S 8 M 3680	460	61,80	89,80	153,50	261,30
S 8 M 3720	465	62,50	90,80	155,30	264,20
S 8 M 3904	488	65,60	95,30	162,80	277,30
S 8 M 4400	550	73,80	107,30	182,80	312,40

Wickelpreise und weitere Abmessungen auf Anfrage.

Prices of sleeves and further dimensions on request.

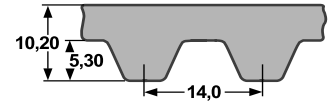

### Type S 14 M - Teilung/Pitch 14 mm

Bezeichnung type	Zähnezahl number of teeth	Breite/width 40 mm Code No. 400 Stück/piece Euro	Breite/width 55 mm Code No. 550 Stück/piece Euro	Breite/width 85 mm Code No. 850 Stück/piece Euro	Breite/width 115 mm Code No. 1150 Stück/piece Euro	Breite/width 170 mm Code No. 1700 Stück/piece Euro
Wirklänge / mm pitch length / mm						
S 14 M 1008	72	80,80	111,40	171,70	231,90	342,50
S 14 M 1120	80	89,30	123,40	190,80	257,80	380,80
S 14 M 1190	85	95,10	131,40	202,70	274,00	404,60
S 14 M 1246	89	99,50	137,90	212,40	287,00	423,70
S 14 M 1400	100	111,90	154,40	238,70	322,40	475,90
S 14 M 1540	110	116,70	160,60	247,30	334,70	493,60
S 14 M 1610	115	119,90	166,50	256,40	347,10	512,60
S 14 M 1652	118	122,50	168,40	259,80	351,70	518,40
S 14 M 1750	125	124,40	171,20	265,00	357,70	529,00
S 14 M 1778	127	126,80	174,00	269,30	363,90	537,10
S 14 M 1806	129	128,70	177,00	273,10	369,80	545,20
S 14 M 1890	135	134,40	185,10	285,90	386,50	571,10
S 14 M 1904	136	135,30	186,50	288,40	389,30	575,40
S 14 M 1960	140	136,90	189,80	293,70	396,30	584,60
S 14 M 2002	143	137,90	191,90	296,50	400,40	590,10
S 14 M 2100	150	143,00	198,00	306,10	412,80	609,30
S 14 M 2240	160	147,20	203,70	315,20	426,00	628,30
S 14 M 2310	165	152,10	211,00	324,80	439,00	649,00
S 14 M 2380	170	155,90	215,30	332,40	449,20	663,50
S 14 M 2450	175	159,70	219,50	339,50	458,50	677,80
S 14 M 2506	179	161,30	222,50	343,90	464,40	686,30
S 14 M 2590	185	163,10	225,70	349,70	472,00	698,30
S 14 M 2660	190	166,90	231,00	362,50	483,10	714,10
S 14 M 2800	200	174,60	242,10	387,90	504,50	745,60
S 14 M 3150	225	186,90	261,70	397,30	538,60	794,50
S 14 M 3248	232	192,70	269,80	409,70	555,40	819,20
S 14 M 3500	250	203,30	280,80	434,30	586,90	868,10
S 14 M 3556	254	206,20	285,10	441,40	596,40	881,90
S 14 M 3850	275	221,00	305,70	471,00	637,10	939,80
S 14 M 4004	286	229,60	317,20	489,70	662,10	978,10
S 14 M 4060	290	248,10	321,60	496,50	715,30	991,80
S 14 M 4326	309	248,20	342,00	528,50	715,00	1055,10
S 14 M 4508	322	258,70	357,40	552,10	745,60	1101,00
S 14 M 5012	358	287,00	397,30	613,60	829,40	1224,00

Wickelpreise und weitere Abmessungen auf Anfrage.

Prices of sleeves and further dimensions on request.

## STS / STD - Neoprene - Zahnflachriemen - doppelt gezahnt STS / STD - Neoprene - Timing Belts - double toothed

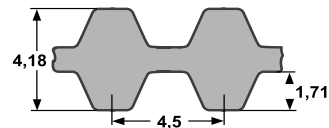

### Type DS 4,5 M - Teilung/Pitch 4,5 mm

Bezeichnung type	Zähnezahl number of teeth	Breite/width 9 mm Code No. 090 Stück/piece Euro	Breite/width 15 mm Code No. 150 Stück/piece Euro	Breite/width 25 mm Code No. 250 Stück/piece Euro
Wirklänge / mm pitch length / mm				
DS 4,5 M 450	100	24,00	34,70	51,60
DS 4,5 M 491	109	24,90	36,50	53,50
DS 4,5 M 504	112	25,20	37,10	54,30
DS 4,5 M 518	115	25,40	37,70	55,50
DS 4,5 M 558	124	25,90	38,80	58,00
DS 4,5 M 563	125	26,30	39,00	58,30
DS 4,5 M 612	136	27,60	40,90	61,50
DS 4,5 M 630	140	28,10	41,60	62,70
DS 4,5 M 711	158	29,40	44,10	65,40
DS 4,5 M 729	162	29,70	44,60	65,90
DS 4,5 M 801	178	31,60	48,20	71,20
DS 4,5 M 1031	229	39,10	54,70	81,30

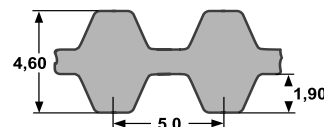

### Type DS 5 M - Teilung/Pitch 5 mm

Bezeichnung type	Zähnezahl number of teeth	9 mm Code No. 090 Stück/piece Euro	15 mm Code No. 150 Stück/piece Euro	25 mm Code No. 250 Stück/piece Euro
Wirklänge / mm pitch length / mm				
DS 5 M 400	80	22,90	33,20	50,20
DS 5 M 425	85	23,70	33,60	51,00
DS 5 M 435	87	25,30	36,40	54,60
DS 5 M 450	90	26,60	38,50	57,40
DS 5 M 475	95	27,40	40,00	58,40
DS 5 M 490	98	27,60	40,60	59,60
DS 5 M 500	100	27,70	40,90	60,20
DS 5 M 520	104	28,30	41,80	61,60
DS 5 M 525	105	28,30	41,80	61,60
DS 5 M 550	110	28,60	42,60	63,70
DS 5 M 560	112	28,70	43,00	64,20
DS 5 M 575	115	29,00	43,40	65,00
DS 5 M 590	118	29,30	44,20	65,80
DS 5 M 600	120	29,60	44,90	66,80
DS 5 M 625	125	30,60	45,80	68,20
DS 5 M 650	130	31,60	47,10	70,90
DS 5 M 665	133	32,20	48,20	71,10
DS 5 M 670	134	32,20	48,20	71,10
DS 5 M 675	135	32,30	48,30	71,40
DS 5 M 690	138	32,40	48,50	72,00
DS 5 M 695	139	32,60	48,60	72,40
DS 5 M 700	140	32,60	48,60	72,40
DS 5 M 725	145	33,10	49,50	73,20
DS 5 M 730	146	33,10	49,50	73,20
DS 5 M 740	148	33,20	50,00	73,50
DS 5 M 750	150	33,40	50,50	74,30
DS 5 M 780	155	34,60	52,40	77,20
DS 5 M 800	160	35,20	53,50	79,20
DS 5 M 830	166	35,90	54,10	80,90
DS 5 M 850	170	36,40	54,40	81,90
DS 5 M 900	180	37,30	56,00	83,60
DS 5 M 950	190	39,10	57,40	85,50
DS 5 M 975	195	40,00	59,40	87,10
DS 5 M 1000	200	40,50	60,00	88,70
DS 5 M 1025	205	40,90	60,90	90,10
DS 5 M 1055	211	41,70	61,60	91,60
DS 5 M 1085	217	42,30	63,10	93,20



## STS / STD - Neoprene - Zahnflachriemen - doppelt gezahnt STS / STD - Neoprene - Timing Belts - double toothed

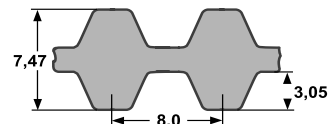

### Type DS 8 M - Teilung/Pitch 8 mm

Bezeichnung type	Zähnezahl number of teeth	Breite/width 20 mm Code No. 200 Stück/piece Euro	Breite/width 30 mm Code No. 300 Stück/piece Euro	Breite/width 50 mm Code No. 500 Stück/piece Euro	Breite/width 85 mm Code No. 850 Stück/piece Euro
Wirklänge / mm pitch length / mm					
DS 8 M 424	53	45,50	68,30	113,50	193,20
DS 8 M 440	55	47,20	70,90	117,80	200,50
DS 8 M 456	57	48,90	73,50	122,10	207,80
DS 8 M 480	60	51,60	77,60	129,00	219,50
DS 8 M 496	62	53,50	80,50	133,40	225,60
DS 8 M 520	65	55,90	84,10	139,10	234,20
DS 8 M 528	66	56,80	85,40	141,30	238,00
DS 8 M 560	70	58,80	87,60	146,00	246,30
DS 8 M 584	73	59,80	89,30	148,40	252,20
DS 8 M 600	75	60,80	90,40	150,00	256,50
DS 8 M 632	79	63,00	94,10	156,80	269,20
DS 8 M 640	80	63,80	94,80	158,30	272,90
DS 8 M 656	82	66,00	98,90	163,40	281,10
DS 8 M 672	84	66,80	99,80	165,50	283,30
DS 8 M 680	85	67,10	100,20	166,70	284,40
DS 8 M 712	89	68,60	101,70	170,80	288,30
DS 8 M 720	90	69,10	102,10	171,60	289,30
DS 8 M 728	91	69,80	103,30	173,10	244,50
DS 8 M 760	95	72,40	106,60	179,00	303,70
DS 8 M 800	100	73,50	110,50	183,80	315,90
DS 8 M 824	103	75,10	112,30	186,70	319,80
DS 8 M 840	105	75,60	113,60	188,50	322,00
DS 8 M 848	106	76,40	114,20	189,50	327,00
DS 8 M 880	110	77,90	116,60	193,10	328,20
DS 8 M 888	111	78,90	117,50	194,90	331,10
DS 8 M 896	112	79,70	118,60	196,80	334,20
DS 8 M 920	115	82,10	121,60	202,60	342,60
DS 8 M 944	118	83,00	123,40	205,30	349,70
DS 8 M 952	119	83,30	123,90	206,30	352,40
DS 8 M 960	120	83,60	124,40	207,30	355,00
DS 8 M 976	122	85,10	126,70	211,40	359,10
DS 8 M 984	123	85,30	126,80	211,90	360,10
DS 8 M 1000	125	86,70	129,00	215,60	365,20
DS 8 M 1032	129	89,10	132,40	220,20	373,40
DS 8 M 1040	130	89,80	133,40	221,50	375,50
DS 8 M 1056	132	90,80	135,30	225,60	383,70
DS 8 M 1080	135	91,90	137,40	228,70	386,60
DS 8 M 1096	137	93,10	138,80	230,90	389,50
DS 8 M 1120	140	94,40	140,80	233,80	402,20
DS 8 M 1136	142	94,80	141,80	235,60	404,20
DS 8 M 1152	144	96,10	143,40	239,90	408,30
DS 8 M 1160	145	96,50	144,40	242,10	410,40
DS 8 M 1184	148	98,50	146,70	244,80	416,40
DS 8 M 1192	149	99,30	147,50	245,20	418,50
DS 8 M 1200	150	99,80	148,50	246,30	420,60
DS 8 M 1216	152	100,70	150,30	248,30	422,60
DS 8 M 1224	153	101,40	151,30	252,40	426,80
DS 8 M 1240	155	102,90	153,30	256,50	433,70
DS 8 M 1248	156	103,80	154,40	258,60	437,10
DS 8 M 1272	159	104,70	155,90	260,10	443,20
DS 8 M 1280	160	105,00	156,40	260,60	445,20
DS 8 M 1296	162	107,30	158,50	266,00	450,30
DS 8 M 1304	163	108,30	159,70	268,90	455,60
DS 8 M 1312	164	108,70	160,30	269,80	456,90
DS 8 M 1344	168	110,00	163,10	274,80	462,70
DS 8 M 1352	169	110,30	163,80	275,80	464,30
DS 8 M 1360	170	110,90	164,50	277,00	465,80
DS 8 M 1384	173	111,20	166,40	280,90	471,90
DS 8 M 1392	174	111,90	167,10	281,60	473,90
DS 8 M 1400	175	112,30	167,90	282,40	476,00
DS 8 M 1424	178	113,20	169,60	283,10	482,10
DS 8 M 1440	180	114,00	170,20	285,20	484,20
DS 8 M 1480	185	116,70	173,90	289,30	494,50



**STS / STD - Neoprene - Zahnflachriemen - doppelt gezahnt**  
**STS / STD - Neoprene - Timing Belts - double toothed**

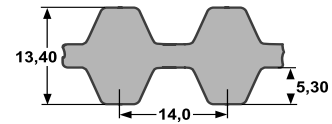

**Type DS 14 M - Teilung/Pitch 14 mm**

Bezeichnung type	Zähnezahl number of teeth	Breite/width 40 mm Code No. 400 Stück/Piece Euro	Breite/width 55 mm Code No. 550 Stück/Piece Euro	Breite/width 85 mm Code No. 850 Stück/Piece Euro	Breite/width 115 mm Code No. 1150 Stück/Piece Euro	Breite/width 170 mm Code No. 1700 Stück/Piece Euro
DS 14 M 1008	72	314,30	433,90	670,00	905,30	1336,20
DS 14 M 1120	80	349,20	482,00	744,60	1005,90	1484,50
DS 14 M 1190	85	371,10	512,30	791,10	1068,90	1577,30
DS 14 M 1246	89	388,50	536,20	828,30	1119,10	1651,60
DS 14 M 1400	100	436,60	602,50	930,80	1257,30	1856,00
DS 14 M 1540	110	455,10	626,70	964,40	1305,70	1925,10
DS 14 M 1610	115	468,20	649,00	999,70	1354,20	1999,50
DS 14 M 1652	118	474,90	655,70	1011,10	1367,90	2020,40
DS 14 M 1750	125	485,40	668,60	1033,00	1395,70	2062,10
DS 14 M 1778	127	493,20	679,20	1049,60	1417,70	2095,00
DS 14 M 1806	129	501,00	689,80	1066,10	1440,00	2127,90
DS 14 M 1890	135	524,20	721,90	1115,30	1507,20	2227,10
DS 14 M 1904	136	528,00	727,20	1123,60	1518,30	2243,70
DS 14 M 2002	143	537,10	747,90	1156,50	1561,10	2301,80
DS 14 M 2100	150	557,80	772,30	1193,80	1609,70	2376,30
DS 14 M 2240	160	574,50	794,60	1229,20	1662,00	2451,00
DS 14 M 2310	165	593,10	822,60	1266,50	1712,30	2531,10
DS 14 M 2380	170	608,50	839,40	1295,50	1750,40	2587,00
DS 14 M 2450	175	623,20	856,20	1324,40	1788,80	2643,20
DS 14 M 2506	179	627,50	865,80	1337,70	1810,20	2664,60
DS 14 M 2590	185	636,10	880,30	1363,60	1841,00	2723,20
DS 14 M 2660	190	651,30	902,00	1413,20	1883,40	2785,00
DS 14 M 2800	200	680,90	943,70	1512,80	1968,00	2907,90
DS 14 M 3150	225	729,40	1020,30	1550,00	2100,30	3098,30
DS 14 M 3248	232	752,10	1052,00	1598,20	2165,60	3194,70
DS 14 M 3500	250	792,70	1095,00	1693,60	2283,10	3385,50
DS 14 M 3556	254	805,40	1112,40	1720,90	2319,50	3439,70
DS 14 M 3850	275	861,70	1191,90	1837,30	2484,50	3665,20
DS 14 M 4004	286	895,30	1236,60	1910,00	2581,40	3814,40
DS 14 M 4060	290	907,80	1253,90	1937,10	2617,50	3867,70
DS 14 M 4326	309	967,20	1336,30	2063,70	2788,80	4120,70
DS 14 M 4508	322	1009,10	1393,40	2152,60	2907,90	4293,80
DS 14 M 5012	358	1119,20	1550,00	2393,10	3234,40	4773,20

Wickelpreise und weitere Abmessungen auf Anfrage.

Prices of sleeves and further dimensions on request.

# ConCar

## Eagle - Neoprene Zahnflachriemen

## Eagle - Neoprene Timing Belt



Yellow (gelb)				
Wirklänge / mm pitch length / mm	Zähneanzahl number of teeth	Teilung pitch	Breite width	Stück/Piece Euro
Y-640	80	8	16	50,60
Y-720	90	8	16	51,90
Y-800	100	8	16	53,40
Y-896	112	8	16	55,30
Y-1000	125	8	16	57,20
Y-1120	140	8	16	60,30
Y-1200	150	8	16	64,40
Y-1280	160	8	16	65,10
Y-1440	180	8	16	73,00
Y-1600	200	8	16	78,90
Y-1792	224	8	16	86,90
Y-2000	250	8	16	95,20
Y-2240	280	8	16	103,20
Y-2400	300	8	16	108,30

Blue (blau)				
Wirklänge / mm pitch length / mm	Zähneanzahl number of teeth	Teilung pitch	Breite width	Stück/Piece Euro
B-994	71	14	35	320,60
B-1120	80	14	35	328,20
B-1190	85	14	35	366,60
B-1260	90	14	35	383,10
B-1400	100	14	35	415,90
B-1568	112	14	35	460,80
B-1750	125	14	35	498,00
B-1960	140	14	35	547,30
B-2100	150	14	35	580,10
B-2240	160	14	35	613,10
B-2380	170	14	35	645,90
B-2520	180	14	35	678,70
B-2660	190	14	35	711,50
B-2800	200	14	35	744,40

White (weiß)				
Wirklänge / mm pitch length / mm	Zähneanzahl number of teeth	Teilung pitch	Breite width	Stück/Piece Euro
W-640	80	8	32	151,50
W-720	90	8	32	156,30
W-800	100	8	32	160,30
W-896	112	8	32	165,80
W-1000	125	8	32	171,50
W-1120	140	8	32	180,90
W-1200	150	8	32	192,90
W-1280	160	8	32	203,00
W-1440	180	8	32	219,20
W-1600	200	8	32	236,40
W-1792	224	8	32	260,90
W-2000	250	8	32	285,80
W-2240	280	8	32	309,40
W-2400	300	8	32	325,10

Green (grün)				
Wirklänge / mm pitch length / mm	Zähneanzahl number of teeth	Teilung pitch	Breite width	Stück/Piece Euro
G-994	71	14	52,5	455,00
G-1120	80	14	52,5	496,90
G-1190	85	14	52,5	520,20
G-1260	90	14	52,5	543,40
G-1400	100	14	52,5	590,10
G-1568	112	14	52,5	646,00
G-1750	125	14	52,5	672,90
G-1960	140	14	52,5	776,60
G-2100	150	14	52,5	823,20
G-2240	160	14	52,5	856,90
G-2380	170	14	52,5	916,40
G-2520	180	14	52,5	988,60
G-2660	190	14	52,5	1.009,60
G-2800	200	14	52,5	1.056,20

Purple (violett)				
Wirklänge / mm pitch length / mm	Zähneanzahl number of teeth	Teilung pitch	Breite width	Stück/Piece Euro
P-720	90	8	64	322,00
P-800	100	8	64	330,20
P-896	112	8	64	341,60
P-1000	125	8	64	353,40
P-1120	140	8	64	372,70
P-1200	150	8	64	397,50
P-1280	160	8	64	418,20
P-1440	180	8	64	451,60
P-1600	200	8	64	487,00

Orange (orange)				
Wirklänge / mm pitch length / mm	Zähneanzahl number of teeth	Teilung pitch	Breite width	Stück/Piece Euro
O-1120	80	14	70	662,90
O-1190	85	14	70	673,80
O-1260	90	14	70	703,90
O-1400	100	14	70	764,30
O-1568	112	14	70	836,80
O-1750	125	14	70	915,20
O-1960	140	14	70	1005,80
O-2100	150	14	70	1.066,10
O-2240	160	14	70	1.126,60
O-2380	170	14	70	1.187,00
O-2520	180	14	70	1.247,20
O-2660	190	14	70	1.307,70
O-2800	200	14	70	1.368,00

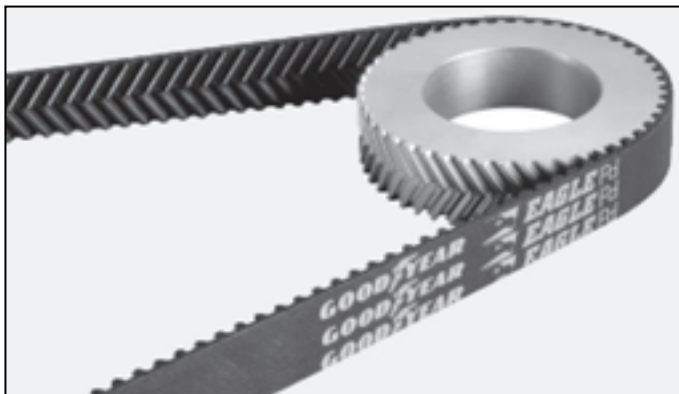

Verfügbarkeit auf Anfrage.

Availability on request.

Red (rot)				
Wirklänge / mm pitch length / mm	Zähneanzahl number of teeth	Teilung pitch	Breite width	Stück/Piece Euro
R-1260	90	14	105	1112,90
R-1400	100	14	105	1208,30
R-1568	112	14	105	1276,60
R-1750	125	14	105	1446,90
R-1960	140	14	105	1590,00
R-2100	150	14	105	1685,40
R-2240	160	14	105	1.783,50
R-2380	170	14	105	1.876,40
R-2520	180	14	105	1.971,90
R-2660	190	14	105	2.067,30
R-2800	200	14	105	2.162,70

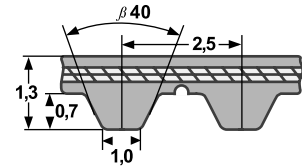

**Type T 2,5 - Teilung/ Pitch 2,5 mm**

Länge length	Breite width	Breite width	Breite width	Breite width	Breite width
	4mm Stück/ piece Euro	6mm Stück/ piece Euro	8mm Stück/ piece Euro	10mm Stück/ piece Euro	12mm Stück/ piece Euro
T2,5 120	6,10	6,70	7,80	8,70	10,40
T2,5 145	6,10	6,70	7,80	8,70	10,40
T2,5 160	6,10	6,70	7,80	8,70	10,40
T2,5 177,5	6,10	6,90	7,80	8,80	10,60
T2,5 180	6,10	6,90	7,80	8,80	10,60
T2,5 182,5	6,10	6,90	7,80	8,80	10,60
T2,5 200	6,50	7,00	7,90	9,00	10,80
T2,5 230	6,50	7,10	8,20	9,10	10,90
T2,5 245	6,50	7,10	8,30	9,20	11,00
T2,5 265	6,70	7,40	8,40	9,30	11,30
T2,5 285	6,90	7,50	8,60	9,50	11,50
T2,5 290	6,90	7,50	8,60	9,50	11,50
T2,5 305	6,90	7,60	8,80	9,70	11,80
T2,5 317,5	7,10	7,80	9,10	10,30	12,10
T2,5 330	7,40	7,90	9,30	10,40	12,40
T2,5 380	7,50	8,30	9,30	10,50	12,70
T2,5 420	7,70	8,40	9,50	10,90	13,10
T2,5 480	8,20	8,80	10,30	11,50	13,70
T2,5 492,5	8,70	9,40	10,90	12,10	14,50
T2,5 500	8,70	9,40	10,90	12,10	14,50
T2,5 540	9,00	9,70	11,40	12,70	15,30
T2,5 600	9,40	10,50	11,90	13,40	16,10
T2,5 620	10,10	10,90	12,60	14,10	16,70
T2,5 650	10,10	10,90	12,60	14,10	16,70
T2,5 680	10,10	11,00	12,70	14,30	17,00
T2,5 700	10,10	11,20	12,90	14,50	17,30
T2,5 780	10,10	11,80	13,40	15,20	18,20
T2,5 880	11,10	12,20	13,90	15,90	19,00
T2,5 915	11,50	12,70	14,40	16,20	19,50
T2,5 950	11,50	12,80	14,60	16,40	19,70
T2,5 1185	14,95	16,64	18,98	21,32	25,61

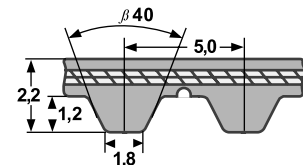

**Type T 5 - Teilung/ Pitch 5 mm**

Länge length	Breite width	Breite width	Breite width	Breite width	Breite width	Breite width	Breite width	Breite width
	6mm Stück/ piece Euro	8mm Stück/ piece Euro	10mm Stück/ piece Euro	12mm Stück/ piece Euro	16 mm Stück/ piece Euro	20 mm Stück/ piece Euro	25 mm Stück/ piece Euro	32 mm Stück/ piece Euro
T5 120	3,94	4,89	5,77	6,64	8,25	9,64	11,10	14,45
T5 150	4,86	6,03	7,11	8,19	10,17	11,88	13,68	17,82
T5 165	5,40	6,70	7,90	9,10	11,30	13,20	15,20	19,80
T5 180	5,40	6,70	7,90	9,10	11,30	13,20	15,20	19,80
T5 185	5,50	6,90	8,20	9,20	11,50	13,50	15,90	20,30
T5 200	5,50	6,90	8,20	9,20	11,50	13,50	15,90	20,30
T5 210	5,60	7,10	8,40	9,40	11,90	14,00	16,20	20,70
T5 215	5,60	7,10	8,40	9,40	11,90	14,00	16,20	20,70
T5 220	5,60	7,10	8,40	9,40	11,90	14,00	16,20	20,70
T5 225	5,60	7,10	8,40	9,40	11,90	14,00	16,20	20,70
T5 245	5,60	7,30	8,60	9,40	12,10	14,20	16,60	21,30
T5 250	5,70	7,40	8,70	9,50	12,50	14,30	16,80	21,50
T5 255	5,70	7,50	8,70	9,90	12,60	14,50	17,00	21,80
T5 260	5,70	7,50	8,70	9,90	12,60	14,50	17,00	21,80
T5 270	6,00	7,60	9,00	10,20	12,70	14,80	17,30	22,20
T5 275	6,00	7,70	9,10	10,30	12,90	15,10	17,50	22,40
T5 280	6,10	7,70	9,20	10,40	13,00	15,20	17,90	22,70
T5 295	6,20	7,80	9,30	10,50	13,20	15,20	18,10	23,30
T5 300	6,40	7,90	9,40	10,70	13,60	15,80	18,40	23,60

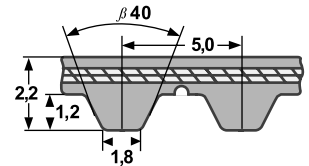

### Type T 5 - Teilung/ Pitch 5 mm

Länge length	Breite width	Breite width	Breite width	Breite width	Breite width	Breite width	Breite width	Breite width
	6mm Stück/ piece Euro	8mm Stück/ piece Euro	10mm Stück/ piece Euro	12mm Stück/ piece Euro	16 mm Stück/ piece Euro	20 mm Stück/ piece Euro	25 mm Stück/ piece Euro	32 mm Stück/ piece Euro
T5 305	6,40	8,00	9,40	10,70	13,60	15,90	18,50	23,60
T5 325	6,50	8,20	9,50	10,90	13,70	16,00	18,70	24,00
T5 330	6,50	8,20	9,50	11,00	13,70	16,10	18,70	24,00
T5 340	6,50	8,20	9,50	11,00	13,70	16,10	18,70	24,00
T5 350	6,70	8,40	9,90	11,20	14,10	16,40	19,30	24,70
T5 355	6,70	8,40	9,90	11,20	14,10	16,40	19,30	24,70
T5 360	6,70	8,40	9,90	11,20	14,10	16,40	19,30	24,70
T5 365	6,70	8,40	9,90	11,20	14,10	16,40	19,30	24,70
T5 375	6,70	8,40	10,20	11,40	14,40	16,80	19,60	25,00
T5 390	6,70	8,40	10,20	11,40	14,40	16,80	19,60	25,00
T5 400	6,70	8,40	10,20	11,40	14,40	16,80	19,60	25,00
T5 410	6,90	8,70	10,40	11,80	12,20	17,00	19,90	25,60
T5 420	7,00	8,80	10,50	11,90	12,40	17,40	20,30	26,10
T5 425	7,00	8,80	10,50	11,90	12,40	17,40	20,30	26,10
T5 440	7,00	8,80	10,50	11,90	12,40	17,40	20,30	26,10
T5 445	7,00	8,80	10,50	11,90	12,40	17,40	20,30	26,10
T5 450	7,00	8,80	10,50	11,90	12,40	17,40	20,30	26,10
T5 455	7,00	8,80	10,50	11,90	12,40	17,40	20,30	26,10
T5 460	7,10	9,10	10,60	12,10	12,60	17,90	20,90	26,60
T5 465	7,10	9,10	10,60	12,10	12,60	17,90	20,90	26,60
T5 475	7,10	9,10	10,60	12,10	12,60	17,90	20,90	26,60
T5 480	7,40	9,20	10,80	12,40	12,90	18,10	21,10	27,00
T5 500	7,60	9,40	11,30	12,80	13,30	18,70	21,90	27,90
T5 510	7,70	9,90	11,50	13,20	13,70	19,40	22,50	29,10
T5 525	7,90	10,30	11,80	13,40	13,90	19,70	23,00	29,50
T5 545	8,20	10,40	12,20	14,00	14,50	20,30	23,80	30,40
T5 550	8,20	10,40	12,20	14,00	14,50	20,30	23,80	30,40
T5 560	8,20	10,40	12,20	14,00	14,50	20,30	23,80	30,40
T5 575	8,30	10,50	12,60	14,10	14,60	20,70	24,10	30,90
T5 590	8,40	10,60	12,70	14,20	14,70	20,90	24,50	31,10
T5 600	8,40	10,70	12,70	14,30	14,80	21,10	24,70	31,50
T5 610	8,60	10,80	12,80	14,50	15,10	21,30	24,80	31,80
T5 620	8,80	11,20	13,20	14,80	15,40	21,90	25,60	32,70
T5 625	8,80	11,20	13,20	14,80	15,40	21,90	25,60	32,70
T5 630	8,80	11,20	13,20	14,80	15,40	21,90	25,60	32,70
T5 640	9,00	11,30	13,30	15,20	15,80	22,20	26,10	33,20
T5 650	9,00	11,30	13,40	15,20	15,80	22,20	26,10	33,20
T5 660	9,10	11,50	13,50	15,50	16,10	22,50	26,40	33,80
T5 675	9,20	11,50	13,70	15,60	16,20	22,70	26,40	34,00
T5 690	9,20	11,50	13,70	15,70	16,30	22,80	26,90	34,30
T5 695	9,30	11,80	14,00	15,80	16,40	23,30	27,10	34,60
T5 700	9,30	11,80	14,00	15,80	16,40	23,30	27,10	34,60
T5 720	9,30	11,80	14,10	15,90	16,50	23,30	27,10	34,60
T5 725	9,30	11,80	14,10	16,00	16,60	23,40	27,10	35,00
T5 750	9,30	11,80	14,10	16,00	16,60	23,40	27,30	35,00
T5 765	9,30	11,80	14,10	16,00	16,60	23,50	27,40	35,10
T5 780	9,40	11,90	14,20	16,00	16,60	23,60	27,50	35,20
T5 800	9,40	12,10	14,30	16,20	16,80	23,90	27,60	35,40
T5 815	9,50	12,20	14,50	16,40	17,00	24,10	28,40	36,30
T5 830	9,70	12,40	14,60	16,50	17,10	24,40	28,50	36,50
T5 840	9,90	12,60	14,60	16,60	17,20	24,60	28,60	36,60
T5 850	10,10	12,60	14,70	16,80	17,40	24,60	28,60	36,70
T5 860	10,20	12,70	14,80	16,90	17,50	24,80	29,10	37,00
T5 885	10,20	12,70	14,80	16,90	17,50	24,80	29,10	37,00
T5 900	10,20	12,70	14,80	16,90	17,50	24,80	29,10	37,00
T5 940	10,40	13,00	15,50	17,40	18,10	25,70	30,00	38,30
T5 975	10,50	13,20	15,70	17,90	18,60	26,10	30,40	39,30
T5 990	10,60	13,40	15,90	18,10	18,80	26,50	30,90	39,50
T5 1000	10,70	13,70	16,10	18,40	19,10	27,00	31,20	40,20
T5 1075	11,90	15,10	18,00	20,30	21,10	29,70	34,60	44,40
T5 1100	12,10	15,50	18,30	20,70	21,50	30,30	35,50	45,40
T5 1115	12,40	15,70	18,60	21,00	21,80	30,60	35,80	45,90
T5 1140	12,70	16,00	18,80	21,40	22,20	31,20	36,60	47,00

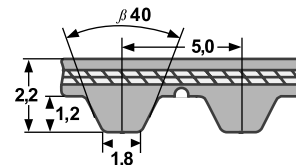

### Type T 5 - Teilung/ Pitch 5 mm

Länge length	Breite width	Breite width	Breite width	Breite width	Breite width	Breite width	Breite width	Breite width
	6mm Stück/ piece Euro	8mm Stück/ piece Euro	10mm Stück/ piece Euro	12mm Stück/ piece Euro	16 mm Stück/ piece Euro	20 mm Stück/ piece Euro	25 mm Stück/ piece Euro	32 mm Stück/ piece Euro
T5 1160	12,90	16,20	19,30	21,80	22,60	32,00	37,60	47,90
T5 1200	13,20	16,70	19,70	22,40	23,30	32,70	38,40	49,10
T5 1215	13,30	16,90	19,90	22,70	23,60	33,20	38,80	49,80
T5 1275	14,50	18,30	21,70	24,70	25,60	36,10	41,90	54,00
T5 1280	14,50	18,30	21,70	24,70	25,60	36,10	41,90	54,00
T5 1315	15,10	19,10	22,40	25,50	26,50	37,60	43,50	56,20
T5 1350	15,30	19,30	22,80	25,80	26,80	38,00	44,50	57,10
T5 1355	15,30	19,30	22,80	25,80	26,80	38,00	44,50	57,10
T5 1380	15,50	19,50	23,10	26,10	27,10	38,30	44,80	57,50
T5 1440	16,10	20,40	24,10	27,40	28,40	40,30	47,10	60,20
T5 1470	17,30	21,20	25,00	28,50	29,50	41,90	49,00	62,60
T5 1500	17,40	22,00	26,00	29,60	30,70	43,50	50,90	65,00
T5 1580	18,70	23,70	28,00	31,80	33,00	46,80	55,10	70,40
T5 1955	21,90	27,70	32,80	37,40	38,80	54,70	63,90	81,90

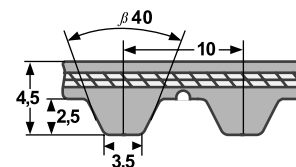

### Type T 10 - Teilung/ Pitch 10 mm

Länge length	Breite width	Breite width	Breite width	Breite width	Breite width	Breite width	Breite width
	10 mm Stück/ piece Euro	12 mm Stück/ piece Euro	16 mm Stück/ piece Euro	20 mm Stück/ piece Euro	25 mm Stück/ piece Euro	32 mm Stück/ piece Euro	50 mm Stück/ piece Euro
T10 260	10,60	12,70	15,90	19,10	23,00	28,20	42,20
T10 320	10,60	12,80	16,00	19,30	23,10	28,40	42,70
T10 340	10,60	12,80	16,00	19,30	23,10	28,40	42,70
T10 370	10,70	12,90	16,10	19,40	23,30	28,60	42,90
T10 390	10,80	13,00	16,10	19,50	23,40	28,80	43,20
T10 400	10,80	13,00	16,10	19,50	23,50	28,90	43,40
T10 410	10,90	13,10	16,20	19,60	23,60	29,00	43,50
T10 440	11,00	13,30	16,50	19,90	23,90	29,50	44,20
T10 450	11,40	13,50	16,90	20,40	24,60	30,20	45,30
T10 480	11,60	14,00	17,40	21,00	25,10	30,90	46,30
T10 500	11,90	14,30	17,90	21,40	25,70	31,50	47,30
T10 530	12,60	15,10	18,60	22,40	27,20	33,20	49,80
T10 550	12,80	15,50	19,30	23,10	27,60	34,20	51,30
T10 560	13,00	15,60	19,50	23,40	28,20	34,60	52,20
T10 600	13,40	16,20	20,00	24,30	29,10	35,80	53,70
T10 610	13,50	16,40	20,60	24,70	29,60	36,30	54,50
T10 630	14,10	16,70	21,00	25,20	30,30	37,40	56,40
T10 650	14,30	17,20	21,40	25,70	31,00	38,10	57,50
T10 660	14,40	17,40	21,80	26,10	31,30	38,40	57,80
T10 680	14,70	17,90	22,00	26,60	31,90	39,20	58,90
T10 690	15,10	18,10	22,20	27,10	32,40	39,80	59,80
T10 700	15,20	18,20	22,70	27,30	32,80	40,30	60,20
T10 720	15,50	18,50	23,10	27,70	33,50	41,10	61,20
T10 730	15,70	18,70	23,40	28,20	33,90	41,60	61,70
T10 750	15,90	18,80	23,60	28,40	34,20	41,90	62,20
T10 780	16,10	19,40	24,00	29,00	34,90	42,90	65,00
T10 800	16,40	19,70	24,60	29,60	35,60	43,60	65,80
T10 810	16,50	19,90	24,80	30,00	35,80	44,20	66,40
T10 840	17,00	20,60	25,60	30,80	37,00	45,50	68,30
T10 850	17,20	20,70	25,70	31,00	37,40	45,70	68,50
T10 880	17,40	21,00	26,00	31,30	37,80	46,30	69,10
T10 890	17,50	21,10	26,20	31,50	38,00	46,80	69,80
T10 900	17,70	21,20	26,50	31,90	38,10	47,00	70,30
T10 910	17,90	21,30	26,60	32,00	38,30	47,20	70,40
T10 920	18,00	21,40	26,70	32,20	38,70	47,30	71,00
T10 950	18,30	22,00	27,40	33,00	39,80	48,60	73,60



**Polyurethan - Zahnflachriemen mit Stahlritzen**  
**Polyurethane - Timing Belts with Steel Cord**

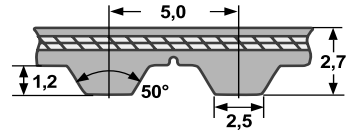

**Type AT 5 Teilung/ Pitch 5 mm**

Länge length	Breite width	Breite width	Breite width	Breite width	Breite width	Breite width	Breite width
	6 mm Stück/ piece Euro	8 mm Stück/ piece Euro	10 mm Stück/ piece Euro	12 mm Stück/ piece Euro	16 mm Stück/ piece Euro	20 mm Stück/ piece Euro	25 mm Stück/ piece Euro
AT5 225	7,00	8,80	10,50	11,80	14,70	17,30	20,10
AT5 255	7,30	9,20	10,90	12,20	15,60	18,10	21,20
AT5 275	7,50	9,40	11,30	12,70	16,00	18,50	21,80
AT5 280	7,60	9,50	11,40	12,90	16,20	18,80	22,10
AT5 300	8,00	9,90	11,80	13,30	16,80	19,50	22,80
AT5 330	8,00	10,30	12,00	13,70	17,20	20,00	23,50
AT5 340	8,00	10,30	12,00	13,70	17,20	20,00	23,50
AT5 375	8,40	10,50	12,60	14,10	17,70	20,70	24,10
AT5 390	8,40	10,60	12,70	14,20	18,00	21,00	24,50
AT5 420	8,70	10,90	13,10	14,70	18,60	21,70	25,30
AT5 450	8,70	10,90	13,10	14,70	18,60	21,70	25,30
AT5 455	8,70	10,90	13,10	14,70	18,60	21,70	25,30
AT5 480	9,10	11,40	14,60	15,30	19,40	22,60	26,30
AT5 500	9,40	11,90	14,10	15,90	19,90	23,30	27,20
AT5 525	9,90	12,50	14,80	16,70	21,00	24,40	28,60
AT5 545	10,30	12,90	15,30	17,30	21,70	25,30	29,60
AT5 600	10,60	13,30	15,80	17,90	22,30	26,20	30,60
AT5 610	10,70	13,40	15,90	18,10	22,50	26,50	30,90
AT5 630	10,90	14,00	16,40	19,20	23,40	27,50	31,20
AT5 660	11,30	14,40	16,80	19,20	24,00	28,20	32,80
AT5 670	11,30	14,40	16,80	19,20	24,10	28,40	33,00
AT5 710	11,50	14,50	17,30	19,50	24,70	28,80	33,60
AT5 720	11,60	14,60	17,50	19,90	24,90	29,00	34,00
AT5 750	11,60	14,60	17,50	19,90	24,90	29,00	34,00
AT5 780	11,80	14,70	17,70	19,90	25,10	29,30	34,30
AT5 825	12,10	15,60	18,30	20,70	26,00	30,50	35,70
AT5 860	12,40	15,80	18,50	21,10	26,50	30,90	36,20
AT5 975	13,00	16,60	19,60	22,10	27,70	32,40	37,90
AT5 1050	14,40	18,30	21,80	24,70	30,80	36,10	42,00
AT5 1125	15,60	19,50	23,40	26,20	33,00	38,60	45,20
AT5 1500	21,00	26,50	31,30	35,60	44,60	52,30	61,20
AT5 2000	27,80	35,20	41,80	47,40	59,60	69,80	81,60
Wickelpreise auf Anfrage.							
Prices of sleeves on request.							

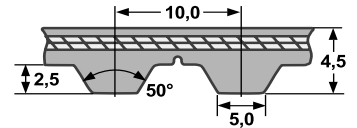

**Type AT 10 - Teilung/ Pitch 10 mm**

Länge length	Breite width	Breite width	Breite width	Breite width	Breite width
	16 mm Stück/ piece Euro	25 mm Stück/ piece Euro	32 mm Stück/ piece Euro	50 mm Stück/ piece Euro	75 mm Stück/ piece Euro
AT10 370	20,80	30,30	37,20	55,60	83,60
AT10 500	21,90	31,90	39,10	58,60	88,00
AT10 560	24,00	34,80	43,00	64,60	96,90
AT10 580	24,40	35,40	43,60	65,50	98,20
AT10 600	24,90	36,00	44,20	66,40	99,50
AT10 610	25,30	36,50	45,20	67,60	101,40
AT10 660	26,90	38,80	47,50	71,90	108,00
AT10 700	27,90	40,50	49,80	74,40	111,70
AT10 730	28,90	41,90	51,40	76,50	114,70
AT10 780	29,70	43,00	53,10	80,20	120,50
AT10 800	30,30	43,70	54,00	81,60	122,60
AT10 810	30,70	44,10	45,50	82,30	123,30
AT10 840	31,90	45,90	56,50	84,20	126,30
AT10 880	32,10	46,30	57,20	85,00	127,40
AT10 890	32,40	46,80	57,80	85,90	128,80
AT10 920	33,00	47,50	58,60	88,00	132,00
AT10 960	34,30	49,80	60,90	91,40	137,10
AT10 980	34,80	50,70	62,00	93,60	140,30
AT10 1000	35,60	51,90	62,90	95,70	143,60
AT10 1010	36,00	52,30	64,60	96,10	144,20
AT10 1050	37,00	53,70	66,40	98,20	147,50
AT10 1080	38,10	55,30	68,10	103,00	154,40
AT10 1100	38,40	55,70	68,90	103,70	155,70
AT10 1150	40,30	58,60	72,20	107,50	161,50
AT10 1200	41,30	60,00	74,00	110,50	165,90
AT10 1210	41,50	60,30	74,00	111,00	166,50
AT10 1220	41,70	60,70	74,20	111,80	167,40
AT10 1230	41,90	61,10	74,40	112,60	168,30
AT10 1240	42,10	61,30	74,60	113,10	169,20
AT10 1250	42,20	61,70	74,70	113,60	170,20
AT10 1280	43,40	62,90	76,50	116,00	174,10
AT10 1300	43,40	63,30	77,00	116,50	174,90
AT10 1320	44,20	64,30	79,90	117,70	176,70
AT10 1350	44,60	65,10	80,20	119,10	178,60
AT10 1360	45,20	65,50	80,90	119,90	180,00
AT10 1400	45,90	66,70	82,50	123,90	185,80
AT10 1420	46,80	68,10	83,80	126,30	189,40
AT10 1480	48,20	70,20	85,90	129,90	194,80
AT10 1500	48,50	71,00	86,40	129,90	194,80
AT10 1600	50,70	73,60	90,20	134,60	202,10
AT10 1630	50,90	73,80	90,70	135,80	203,90
AT10 1700	51,40	74,40	91,90	138,30	207,50
AT10 1720	51,90	75,40	93,00	139,50	209,30
AT10 1800	53,70	77,90	95,70	144,30	216,50
AT10 1860	56,20	81,20	99,40	150,30	225,60
AT10 1940	58,60	84,70	103,70	156,30	234,50
Wickelpreise auf Anfrage. Prices of sleeves on request.					

**Polyurethan - Zahnflachriemen mit Stahllitzen - doppelt gezahnt**  
**Polyurethane - Timing Belts with Steel Cord - double toothed**

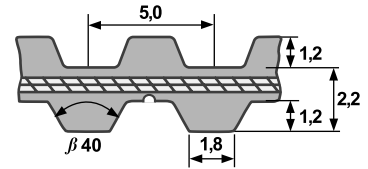

**Type DT 5 - Teilung/ Pitch 5 mm**

Länge length	Breite width							
	6 mm Stück/ piece Euro	8 mm Stück/ piece Euro	10 mm Stück/ piece Euro	12 mm Stück/ piece Euro	16 mm Stück/ piece Euro	20 mm Stück/ piece Euro	25 mm Stück/ piece Euro	32 mm Stück/ piece Euro
DT5 300	8,70	10,80	12,70	15,20	18,80	22,00	26,90	32,80
DT5 410	8,70	10,80	12,70	15,20	18,80	22,00	26,90	33,80
DT5 460	8,70	11,00	12,90	15,50	19,30	22,30	27,40	34,30
DT5 480	8,80	11,00	13,00	15,60	19,50	22,40	27,40	34,60
DT5 500	9,20	11,50	13,50	16,20	20,10	23,50	28,80	36,20
DT5 515	9,30	11,90	13,90	16,70	20,70	23,90	29,50	36,80
DT5 550	9,90	12,40	14,50	17,40	21,80	25,20	30,90	38,70
DT5 590	9,90	12,60	14,50	17,50	21,90	25,30	31,00	39,00
DT5 620	10,30	12,80	15,10	18,10	22,30	26,00	31,90	40,00
DT5 650	10,60	13,30	15,70	18,70	23,40	27,10	33,00	41,60
DT5 685	10,80	13,50	16,00	19,30	23,80	27,60	33,90	42,70
DT5 700	10,80	13,50	16,00	19,30	23,80	27,60	33,90	42,70
DT5 750	11,30	14,10	16,60	19,80	24,80	28,80	35,20	44,20
DT5 800	13,50	17,00	20,00	24,10	30,00	34,90	42,90	53,00
DT5 815	13,90	17,20	20,00	24,60	30,10	35,00	42,90	53,70
DT5 860	14,10	17,70	20,70	24,80	30,90	35,80	43,90	54,90
DT5 900	14,30	18,00	21,00	25,10	31,20	36,20	44,40	55,90
DT5 940	14,30	18,10	21,10	25,30	31,50	36,60	44,80	56,40
DT5 1075	15,70	19,60	22,80	27,60	37,40	39,70	48,20	60,20
DT5 1100	16,00	20,00	23,40	28,20	38,20	40,60	49,30	61,60

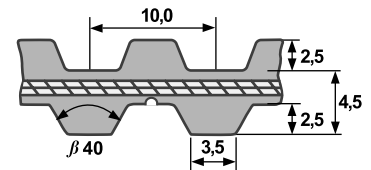

**Type DT 10 - Teilung/ Pitch 10 mm**

Länge length	Breite width						
	10 mm Stück/ piece Euro	12 mm Stück/ piece Euro	16 mm Stück/ piece Euro	20 mm Stück/ piece Euro	25 mm Stück/ piece Euro	32 mm Stück/ piece Euro	50 mm Stück/ piece Euro
DT10 260	15,30	17,20	21,20	25,00	31,30	37,20	55,90
DT10 530	16,50	19,50	24,70	29,70	36,60	44,90	67,50
DT10 600	18,60	22,00	27,80	33,70	41,40	50,90	76,20
DT10 630	18,70	22,20	28,20	33,90	41,60	51,30	77,20
DT10 660	20,00	23,80	30,10	36,30	44,60	54,90	82,70
DT10 700	21,00	24,80	31,30	37,90	46,20	57,30	86,10
DT10 720	21,50	25,30	32,30	38,70	47,50	58,60	91,60
DT10 800	23,10	27,30	34,60	41,70	51,30	63,30	96,10
DT10 840	23,70	27,90	35,50	42,90	52,60	64,70	100,80
DT10 900	25,60	30,10	38,10	46,00	56,40	68,90	108,60
DT10 920	26,20	30,80	38,90	47,00	57,70	70,40	111,00
DT10 980	27,20	32,30	40,60	48,90	59,70	74,40	115,50
DT10 1100	30,00	35,40	44,70	53,70	66,20	81,80	127,10
DT10 1210	32,50	38,40	48,50	58,20	72,00	88,70	138,70
DT10 1240	34,50	40,60	51,30	62,80	76,20	93,80	146,90
DT10 1250	37,90	44,60	56,90	68,00	83,70	103,10	160,80
DT10 1320	39,70	46,70	58,60	71,70	87,80	108,60	168,70
DT10 1350	40,60	48,20	60,00	73,00	90,20	110,90	172,30
DT10 1420	42,20	49,90	63,70	76,20	93,30	115,10	180,20
DT10 1500	43,00	50,90	64,30	77,20	94,70	116,90	182,60
DT10 1610	43,40	51,30	65,20	78,20	96,50	118,90	184,80
DT10 1700	44,10	52,20	66,20	79,50	97,60	120,60	188,10
DT10 1800	44,80	52,60	67,00	81,00	99,30	122,00	190,40
DT10 1880	45,40	53,70	67,50	81,80	100,80	124,20	193,20

Wickelpreise auf Anfrage.

Prices of sleeves on request.

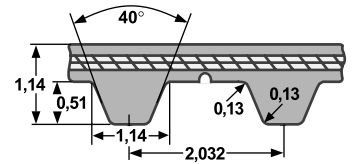

**Type MXLPU - Teilung/ Pitch 2,032 mm**

	Zoll / Inch mm Zoll / Inch		Breite / width			
			1/8 3,175 012	3/16 4,763 019	1/4 6,35 025	
	Wirklänge pitch length Zoll / inch    mm		Zähne teeth	Stück piece Euro	Stück piece Euro	Stück piece Euro
440 MXLPU	4,40	111,7	55	4,60	6,90	8,90
456 MXLPU	4,56	115,8	57	4,60	6,90	8,90
480 MXLPU	4,80	121,9	60	4,60	6,90	8,90
560 MXLPU	5,60	142,2	70	4,60	6,90	8,90
576 MXLPU	5,76	146,3	72	4,60	6,90	8,90
600 MXLPU	6,00	152,4	75	4,60	6,90	8,90
608 MXLPU	6,08	154,4	76	4,60	6,90	8,90
632 MXLPU	6,32	160,5	79	4,60	6,90	8,90
640 MXLPU	6,40	162,5	80	4,60	6,90	8,90
656 MXLPU	6,56	166,6	82	4,60	6,90	8,90
704 MXLPU	7,04	178,8	88	4,60	6,90	8,90
728 MXLPU	7,28	184,9	91	4,60	6,90	8,90
736 MXLPU	7,36	186,9	92	4,60	6,90	8,90
768 MXLPU	7,68	195,1	96	4,60	6,90	8,90
808 MXLPU	8,08	205,2	101	4,60	6,90	8,90
816 MXLPU	8,16	207,2	102	4,60	6,90	8,90
824 MXLPU	8,24	209,2	103	4,60	6,90	8,90
840 MXLPU	8,40	213,4	105	4,60	6,90	8,90
880 MXLPU	8,80	223,5	110	4,60	6,90	8,90
912 MXLPU	9,12	231,6	114	4,60	6,90	8,90
944 MXLPU	9,44	239,7	118	4,60	6,90	8,90
960 MXLPU	9,60	243,8	120	4,60	6,90	8,90
1040 MXLPU	10,40	264,1	130	4,80	7,10	9,20
1056 MXLPU	10,56	268,2	132	4,80	7,10	9,20
1080 MXLPU	10,80	274,3	135	4,80	7,20	9,20
1120 MXLPU	11,20	284,4	140	4,80	7,20	9,20
1160 MXLPU	11,60	294,6	145	5,00	7,50	9,60
1200 MXLPU	12,00	304,8	150	5,00	7,50	9,60
1240 MXLPU	12,40	314,9	155	5,10	7,50	9,60
1400 MXLPU	14,00	355,6	175	5,40	7,90	10,10
1520 MXLPU	15,20	386,1	190	5,60	8,30	10,70
1600 MXLPU	16,00	406,4	200	5,60	8,30	10,70
1768 MXLPU	17,68	449,1	221	7,10	10,40	13,40
2048 MXLPU	20,48	520,1	256	7,10	10,40	13,40
2240 MXLPU	22,40	568,9	280	7,10	10,40	13,40
2280 MXLPU	22,80	579,1	285	7,20	10,60	13,70
2464 MXLPU	24,64	625,8	308	7,50	11,20	14,40
2656 MXLPU	26,56	674,6	332	7,50	11,20	14,40
2816 MXLPU	28,16	715,2	352	8,00	11,80	15,10
2880 MXLPU	28,80	731,5	360	8,00	11,80	15,10
3160 MXLPU	31,60	802,6	395	8,30	12,20	15,70
3240 MXLPU	32,40	822,9	405	8,30	12,20	15,70
3296 MXLPU	32,96	837,1	412	8,30	12,20	15,70
3456 MXLPU	34,56	877,8	432	8,30	12,20	15,70
3632 MXLPU	36,32	922,5	454	11,40	16,80	21,60
3880 MXLPU	38,80	985,5	485	12,20	18,00	23,10
Mindestmenge und Lieferzeit auf Anfrage.						
Minimum quantity and delivery time on request.						

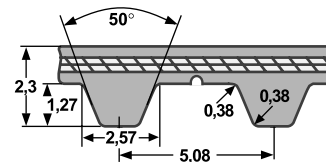

**Type XLPU - Teilung/ Pitch 5,08 mm**

	Zoll/ Inch mm		Zähne teeth	Breite/width ¼	Breite/width 5/16	Breite/width 3/8
	Zoll/ Inch	mm		6,35 025	7,94 031	9,53 037
	Wirklänge pitch length		Stück piece Euro	Stück piece Euro	Stück piece Euro	Stück piece Euro
	Zoll/ inch	mm				
60 XLPU	6,0	152,4	30	6,20	7,60	8,40
70 XLPU	7,0	177,8	35	6,20	7,60	8,40
76 XLPU	7,6	193,0	38	6,30	7,70	8,60
80 XLPU	8,0	203,2	40	6,30	7,70	8,60
90 XLPU	9,0	228,6	45	6,40	7,90	8,60
100 XLPU	10,0	254,0	50	6,50	8,00	8,80
110 XLPU	11,0	279,4	55	6,50	8,00	8,80
120 XLPU	12,0	304,8	60	6,80	8,40	9,20
130 XLPU	13,0	330,2	65	6,80	8,40	9,30
134 XLPU	13,4	340,3	67	7,10	8,80	9,60
140 XLPU	14,0	355,6	70	7,20	8,90	9,70
150 XLPU	15,0	381,0	75	7,20	8,90	9,70
160 XLPU	16,0	406,4	80	7,50	9,20	10,10
170 XLPU	17,0	431,8	85	7,60	9,50	10,40
180 XLPU	18,0	457,2	90	7,60	9,50	10,40
190 XLPU	19,0	482,6	95	7,70	9,50	10,60
194 XLPU	19,4	492,7	97	8,00	9,80	10,80
200 XLPU	20,0	508,0	100	8,20	10,00	11,10
210 XLPU	21,0	533,4	105	8,50	10,40	11,50
220 XLPU	22,0	558,8	110	8,70	10,80	11,90
230 XLPU	23,0	584,2	115	9,50	11,60	12,80
240 XLPU	24,0	609,6	120	9,50	11,60	12,80
250 XLPU	25,0	635,0	125	10,10	12,50	13,80
260 XLPU	26,0	660,4	130	10,30	12,70	14,10
270 XLPU	27,0	685,8	135	10,80	13,30	14,70
288 XLPU	28,8	731,5	144	11,50	14,20	15,70
290 XLPU	29,0	736,6	145	11,60	14,30	15,80
300 XLPU	30,0	762,0	150	12,00	14,70	16,30
356 XLPU	35,6	904,2	178	14,20	17,60	19,40
414 XLPU	41,4	1051,5	207	16,50	20,40	22,40
450 XLPU	45,0	1143,0	225	17,90	22,10	24,40
566 XLPU	56,6	1437,6	283	18,60	22,90	25,20

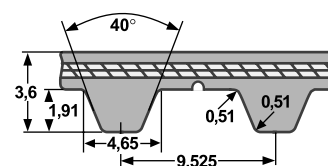

**Type LPU - Teilung/ Pitch 9,525 mm**

	Zoll/ inch mm		Zähne teeth	Breite/width 1/2	Breite/width ¾	Breite/width 1
	Zoll/ inch	mm		12,7 050	19,05 075	25,4 100
	Wirklänge pitch length		Stück piece Euro	Stück piece Euro	Stück piece Euro	Stück piece Euro
	Zoll/ inch	mm				
86 LPU	8,6	219,0	23	13,40	17,90	22,60
124 LPU	12,4	314,3	33	13,40	17,90	22,60
150 LPU	15,0	381,0	40	13,60	18,30	22,90
173 LPU	17,3	438,1	46	14,40	19,30	24,20
187 LPU	18,7	476,2	50	14,90	19,90	25,00
202 LPU	20,2	514,4	54	15,50	20,80	26,20
210 LPU	21,0	533,4	56	15,50	20,80	26,20
225 LPU	22,5	571,5	60	16,40	22,00	27,60
240 LPU	24,0	609,6	64	16,50	22,10	27,80
255 LPU	25,5	647,7	68	16,60	22,30	28,00
270 LPU	27,0	685,8	72	17,20	23,00	29,00
285 LPU	28,5	723,9	76	17,50	23,50	29,50
300 LPU	30,0	762,0	80	17,90	24,10	30,20
322 LPU	32,2	819,1	86	20,00	26,70	33,50

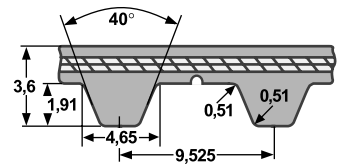

**Type LPU - Teilung/ Pitch 9,525 mm**

	Zoll/ inch mm	Zoll/ inch	Breite/width			
			1/2 12,7 050	3/4 19,05 075	1 25,4 100	
	Wirklänge pitch length		Zähne teeth	Stück piece Euro	Stück piece Euro	Stück piece Euro
	Zoll/ inch	mm				
345 LPU	34,5	876,3	92	21,80	29,20	36,80
367 LPU	36,7	933,4	98	23,90	32,10	40,30
390 LPU	39,0	990,6	104	26,50	35,40	44,50
420 LPU	42,0	1066,8	112	26,80	35,90	45,10
450 LPU	45,0	1143,0	120	27,50	37,00	46,40
480 LPU	48,0	1219,2	128	29,80	39,90	50,20
510 LPU	51,0	1295,4	136	32,30	43,30	54,40
540 LPU	54,0	1371,6	144	34,40	46,10	58,00
570 LPU	57,0	1447,8	152	35,40	47,50	59,60
600 LPU	60,0	1524,0	160	35,40	47,50	59,60

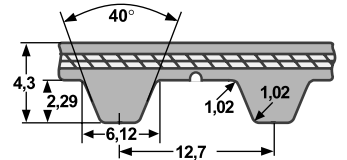

**Type HPU - Teilung/ Pitch 12,7 mm**

	Zoll/ inch mm	Zoll/ inch	Breite/width					
			3/4 19,05 075	1 25,4 100	1 1/2 38,1 150	2 50,8 200	3 76,2 300	
	Wirklänge pitch length		Zähne teeth	Stück piece Euro	Stück piece Euro	Stück piece Euro	Stück piece Euro	Stück piece Euro
	Zoll/ inch	mm						
230 HPU	23	584,2	46	23,90	26,70	40,00	53,30	79,90
240 HPU	24	609,6	48	23,90	26,70	40,00	53,30	79,90
270 HPU	27	685,8	54	24,90	27,80	41,60	55,40	83,20
300 HPU	30	762,0	60	26,00	29,00	43,50	58,00	86,90
330 HPU	33	838,2	66	28,90	32,20	48,30	64,40	96,60
360 HPU	36	914,4	72	33,50	37,40	56,10	74,80	112,10
390 HPU	39	990,6	78	38,30	42,80	64,10	85,40	128,20
420 HPU	42	1066,8	84	38,80	43,30	65,00	86,60	129,70
450 HPU	45	1143,0	90	40,00	44,50	66,80	89,00	133,50
480 HPU	48	1219,2	96	41,20	46,00	69,00	91,90	137,90
510 HPU	51	1295,4	102	46,80	52,30	78,40	104,50	156,60
Verfügbarkeit auf Anfrage.								
Availability on request.								

**Polyurethan - Zahnflachriemen/ Meterware - endlich und endlos verschweißt**  
**Polyurethane Timing Belts - open ended and jointed**

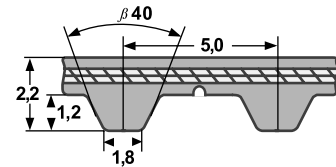

**Type T 5 - Teilung/ Pitch 5 mm**

	Breite width 10 mm	Breite width 16 mm	Breite width 25 mm	Breite width 32 mm	Breite width 50 mm	Breite width 100 mm
	Meter Euro	Meter Euro	Meter Euro	Meter Euro	Meter Euro	Meter Euro
Stahlzugträger steel cord	10,50	16,80	25,00	32,00	45,50	91,10
Kevlarzugträger Kevlar cord	11,50	18,50	27,50	35,20	50,00	100,30
Stahl - PAZ steel - PAZ	12,00	19,40	28,90	36,70	52,40	104,80
Kevlar - PAZ Kevlar - PAZ	13,20	21,40	31,60	40,40	57,50	115,40
Stahl - PAZ / PAR steel - PAZ / PAR	13,50	21,90	32,50	41,60	59,20	118,50
Kevlar - PAZ / PAR Kevlar - PAZ / PAR	15,10	24,00	35,70	45,80	65,00	130,50
Verbindung/ Stück joint/ piece	14,60	14,60	21,40	28,20	35,60	56,40

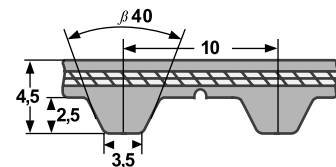

**Type T 10 - Teilung/ Pitch 10 mm**

	Breite width 16 mm	Breite width 25 mm	Breite width 32 mm	Breite width 50 mm	Breite width 75 mm	Breite width 100 mm	Breite width 150 mm
	Meter Euro	Meter Euro	Meter Euro	Meter Euro	Meter Euro	Meter Euro	Meter Euro
Stahlzugträger steel cord	17,50	21,10	27,90	35,00	52,80	67,20	100,80
Kevlarzugträger Kevlar cord	19,30	23,10	30,80	38,40	58,20	74,00	110,80
Stahl - PAZ steel - PAZ	20,00	24,10	32,20	40,20	60,90	77,20	115,80
Kevlar - PAZ Kevlar - PAZ	22,20	26,50	35,50	44,20	67,00	84,90	127,60
Stahl - PAZ / PAR steel - PAZ / PAR	22,70	27,20	36,20	45,50	68,90	87,30	131,00
Kevlar - PAZ / PAR Kevlar - PAZ / PAR	25,00	30,00	40,00	50,00	75,80	96,10	144,00
Verbindung/ Stück joint/ piece	14,60	21,40	28,20	35,60	45,40	56,40	85,70

V = Verbindung

Rolle = 50 oder 100 m

Aufpreis für Anschnitte: 10%

V = joint

roll = 50 or 100 m

Surcharge for shorter lengths: 10%

**Polyurethan - Zahnflachriemen/ Meterware - endlich und endlos verschweißt**  
**Polyurethane Timing Belts - open ended and jointed**

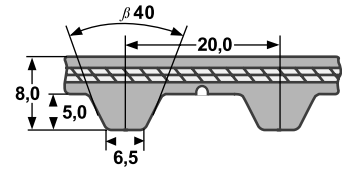

**Type T 20 - Teilung/ Pitch 20 mm**

	Breite width	Breite width	Breite width	Breite width	Breite width	Breite width
	25 mm	32 mm	50 mm	75 mm	100 mm	150 mm
	Meter Euro	Meter Euro	Meter Euro	Meter Euro	Meter Euro	Meter Euro
Stahlzugträger steel cord	34,60	46,00	62,90	96,10	119,70	188,70
Stahl - PAZ steel - PAZ	39,70	52,80	72,20	110,70	137,70	217,10
Verbindung/ Stück joint/ piece	21,40	28,20	35,60	45,40	56,40	85,70

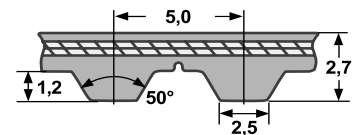

**Type AT 5 - Teilung/ Pitch 5 mm**

	Breite width	Breite width	Breite width	Breite width	Breite width
	10 mm	16 mm	25 mm	32 mm	50 mm
	Meter Euro	Meter Euro	Meter Euro	Meter Euro	Meter Euro
Stahlzugträger steel cord	14,00	19,50	29,30	37,00	51,20
Stahl - PAZ steel - PAZ	16,00	22,40	33,80	42,70	59,10
Verbindung/ Stück joint/ piece	14,60	14,60	21,40	28,20	35,60

V = Verbindung

Rolle = 50 oder 100 m

Aufpreis für Anschnitte: 10%

V = joint

roll = 50 or 100 m

Surcharge for shorter lengths: 10%

**Polyurethan - Zahnflachriemen/ Meterware - endlich und endlos verschweißt**  
**Polyurethane Timing Belts - open ended and jointed**

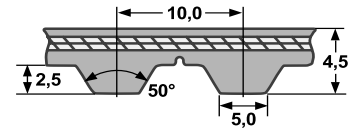

**Type AT 10 - Teilung/ Pitch 10 mm**

	Breite width	Breite width	Breite width	Breite width	Breite width	Breite width	Breite width
	16 mm	25 mm	32 mm	50 mm	75 mm	100 mm	150 mm
	Meter Euro	Meter Euro	Meter Euro	Meter Euro	Meter Euro	Meter Euro	Meter Euro
Stahlzugträger steel cord	22,40	26,10	33,50	42,80	64,90	83,60	125,40
Stahl - PAZ steel - PAZ	26,00	30,10	38,60	49,10	74,50	96,10	144,20
Verbindung/ Stück joint/ piece	14,60	21,40	28,20	35,60	45,40	56,40	85,70

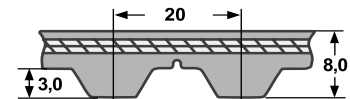

**Type AT 20 - Teilung/ Pitch 20 mm**

	Breite width	Breite width	Breite width	Breite width	Breite width	Breite width
	25 mm	32 mm	50 mm	75 mm	100 mm	150 mm
	Meter Euro	Meter Euro	Meter Euro	Meter Euro	Meter Euro	Meter Euro
Stahlzugträger steel cord	39,20	50,00	71,50	107,10	142,90	204,10
Stahl - PAZ steel - PAZ	47,40	57,50	82,10	123,10	164,30	234,80
Verbindung/ Stück joint/ piece	21,40	28,20	35,60	45,40	56,40	85,70

V = Verbindung

Rolle = 50 oder 100 m

Aufpreis für Anschnitte: 10%

V = joint

roll = 50 or 100 m

Surcharge for shorter lengths: 10%

**Polyurethan - Zahnflachriemen/ Meterware - endlich und endlos verschweißt**

**Polyurethane Timing Belts - open ended and jointed**

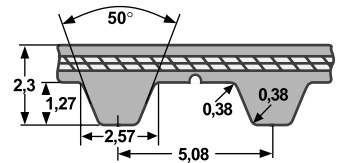

### Type XL - Teilung/ Pitch 5,08 mm

	Breite/width	Breite/width	Breite/width	Breite/width	Breite/width
Zoll/ inch	3/8	1/2	3/4	1	2
mm	9,53	12,7	19,05	25,4	50,8
Zoll/ inch	037	050	075	100	200
	Meter	Meter	Meter	Meter	Meter
	Euro	Euro	Euro	Euro	Euro
Stahlzugträger steel cord	12,80	15,90	23,70	30,20	57,40
Stahl - PAZ steel - PAZ	14,60	18,40	27,30	34,80	66,10
Kevlar - PAZ Kevlar - PAZ	16,00	20,10	29,90	38,20	72,70
Verbindung/ Stück joint/ piece	14,60	14,60	21,40	21,40	35,60

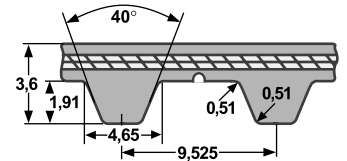

### Type L - Teilung/ Pitch 9,525 mm

	Breite/width	Breite/width	Breite/width	Breite/width	Breite/width
Zoll/ inch	1/2	3/4	1	1 1/2	2
mm	12,7	19,05	25,4	38,1	50,8
Zoll/ inch	050	075	100	150	200
	Meter	Meter	Meter	Meter	Meter
	Euro	Euro	Euro	Euro	Euro
Stahlzugträger steel cord	15,90	23,70	30,20	43,90	57,40
Stahl - PAZ steel - PAZ	18,40	27,30	34,80	50,60	66,10
Kevlar - PAZ Kevlar - PAZ	20,10	29,90	38,20	55,60	72,70
Verbindung/ Stück joint/ piece	14,60	21,40	21,40	35,60	35,60

V = Verbindung

Rolle = 50 oder 100 m

Aufpreis für Anschnitte: 10%

V = joint

roll = 50 or 100 m

Surcharge for shorter lengths: 10%

**Polyurethan - Zahnflachriemen/ Meterware - endlich und endlos verschweißt**  
**Polyurethane Timing Belts - open ended and jointed**

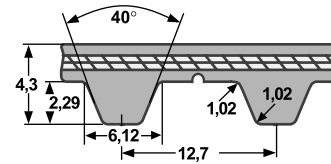

**Type H - Teilung/ Pitch 12,7 mm**

	Breite/width	Breite/width	Breite/width	Breite/width	Breite/width	Breite/width	Breite/width
Zoll/ inch	¾	1	1 1/2	2	3	4	6
mm	19,05	25,4	38,1	50,8	76,2	101,6	152,4
Zoll/ inch	075	100	150	200	300	400	600
	Meter	Meter	Meter	Meter	Meter	Meter	Meter
	Euro	Euro	Euro	Euro	Euro	Euro	Euro
Stahlzugträger steel cord	19,40	21,10	28,20	35,00	52,80	67,20	100,80
Kevlarzugträger Kevlar cord	21,30	23,00	31,00	38,40	58,20	74,00	110,90
Stahl - PAZ steel - PAZ	22,30	24,10	32,50	40,20	60,70	77,20	115,80
Kevlar - PAZ Kevlar - PAZ	24,60	26,50	35,70	44,10	67,00	84,90	127,60
Verbindung/ Stück joint/ piece	21,40	21,40	35,60	35,60	45,40	56,40	85,70

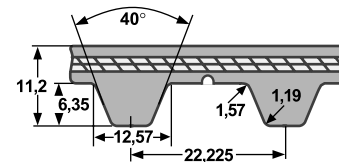

**Type XH - Teilung/ Pitch 22,225 mm**

	Breite/width	Breite/width	Breite/width	Breite/width
Zoll/ inch	1	2	3	4
mm	25,4	50,8	76	101,6
Zoll/ inch	100	200	300	400
	Meter	Meter	Meter	Meter
	Euro	Euro	Euro	Euro
Stahlzugträger steel cord	41,60	69,10	104,60	133,00
Stahl - PAZ steel - PAZ	47,90	79,60	120,40	152,90
Verbindung/ Stück joint/ piece	21,40	35,60	45,40	56,40

V = Verbindung

Rolle = 50 oder 100 m

Aufpreis für Anschnitte: 10%

V = joint

roll = 50 or 100 m

Surcharge for shorter lengths: 10%

**Polyurethan - Zahnflachriemen/ Meterware - endlich und endlos verschweißt**  
**Polyurethane Timing Belts - open ended and jointed**

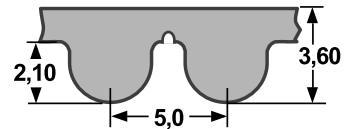

**Type 5M - Teilung/ Pitch 5 mm**

	Breite width	Breite width	Breite width	Breite width
	10 mm	15 mm	25 mm	30 mm
	Meter Euro	Meter Euro	Meter Euro	Meter Euro
Stahlzugträger steel cord	11,50	15,60	28,30	48,10
Stahl - PAZ steel - PAZ	13,20	17,90	32,60	55,20
Verbindung/ Stück joint/ piece	14,60	14,60	21,40	35,60

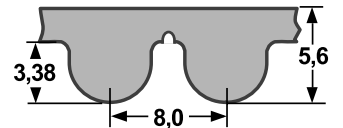

**Type 8M - Teilung/ Pitch 8 mm**

	Breite width	Breite width	Breite width	Breite width	Breite width	Breite width
	20 mm	25 mm	30 mm	50 mm	85 mm	100 mm
	Meter Euro	Meter Euro	Meter Euro	Meter Euro	Meter Euro	Meter Euro
Stahlzugträger steel cord	23,30	24,30	31,10	39,70	60,30	77,60
Stahl - PAZ steel - PAZ	26,90	27,90	35,80	45,60	69,30	89,00
Verbindung/ Stück joint/ piece	21,40	21,40	28,20	35,60	45,40	56,40

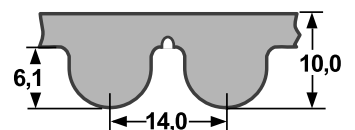

**Type 14M - Teilung/ Pitch 14 mm**

	Breite width	Breite width	Breite width	Breite width	Breite width	Breite width
	25 mm	40 mm	55 mm	85 mm	100 mm	115 mm
	Meter Euro	Meter Euro	Meter Euro	Meter Euro	Meter Euro	Meter Euro
Stahlzugträger steel cord	38,60	50,90	70,20	115,50	153,70	192,00
Stahl - PAZ steel - PAZ	44,40	58,40	80,80	133,00	176,90	221,00
Verbindung/ Stück joint/ piece	21,40	35,60	35,60	45,40	56,40	68,80

V = Verbindung

Rolle = 50 oder 100 m

Aufpreis für Anschnitte: 10%

V = joint

roll = 50 or 100 m

Surcharge for shorter lengths: 10%

Long Length - HTD Neoprene Meterware

Long Length - HTD Neoprene Timing Belts open ended

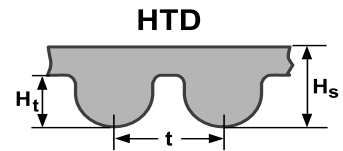

Type 3M - Teilung/ Pitch 3 mm				Type 5M - Teilung/ Pitch 5 mm			
Type	Breite width	Glasfaserzugstrang fibreglass cord		Type	Breite width	Glasfaserzugstrang fibreglass cord	Stahlzugstrang steel cord
		Meter/ Euro				Meter/ Euro	Meter/ Euro
LL-HTD 3M	6 mm	5,40		LL-HTD 5M	6 mm	5,40	7,20
LL-HTD 3M	9 mm	8,90		LL-HTD 5M	10 mm	9,00	11,80
LL-HTD 3M	15 mm	13,40		LL-HTD 5M	15 mm	13,50	17,60
				LL-HTD 5M	25 mm	22,60	29,20

Type 8M - Teilung/ Pitch 8 mm				Type 14M - Teilung/ Pitch 14 mm			
Type	Breite width	Glasfaserzugstrang fibreglass cord	Stahlzugstrang steel cord	Type	Breite width	Glasfaserzugstrang fibreglass cord	Stahlzugstrang steel cord
		Meter/ Euro	Meter/ Euro			Meter/ Euro	Meter/ Euro
LL-HTD 8M	10 mm	11,80	15,70	LL-HTD 14M	25 mm	52,40	70,80
LL-HTD 8M	15 mm	17,80	23,60	LL-HTD 14M	40 mm	84,10	113,50
LL-HTD 8M	20 mm	24,00	31,20	LL-HTD 14M	55 mm	115,60	155,90
LL-HTD 8M	30 mm	35,90	46,80	LL-HTD 14M	85 mm	178,30	241,60
LL-HTD 8M	50 mm	59,60	78,20	LL-HTD 14M	115 mm	241,60	325,90
LL-HTD 8M	85 mm	101,10	132,90				

Type 3MR - Teilung/ Pitch 3 mm				Type 5MR - Teilung/ Pitch 5 mm			
Type	Breite width	Glasfaserzugstrang fibreglass cord		Type	Breite width	Glasfaserzugstrang fibreglass cord	Stahlzugstrang steel cord
		Meter/ Euro				Meter/ Euro	Meter/ Euro
LL-GT 3MR	6 mm	6,40		LL-GT 5MR	6 mm	6,40	8,30
LL-GT 3MR	9 mm	9,40		LL-GT 5MR	10 mm	10,40	13,50
LL-GT 3MR	15 mm	15,70		LL-GT 5MR	15 mm	15,70	20,30
				LL-GT 5MR	25 mm	25,90	33,60

Type 8MR - Teilung/ Pitch 8 mm			
Type	Breite width	Glasfaserzugstrang fibreglass cord	Stahlzugstrang steel cord
		Meter/ Euro	Meter/ Euro
LL-GT 8MR	10 mm	13,50	17,90
LL-GT 8MR	15 mm	20,60	27,10
LL-GT 8MR	20 mm	27,50	36,00
LL-GT 8MR	30 mm	41,20	53,90
LL-GT 8MR	50 mm	68,50	89,70

Rolle = 30 m      Aufpreis für Anschnitte: 10%

roll = 30 m      Surcharge for shorter lengths: 10%

	Metergewicht (g/25 mm Breite)		t (mm)	H <sub>s</sub> (mm)	H <sub>t</sub> (mm)
	Glas	Stahl			
LL-HTD 3M	53		3	2,4	1,2
LL-HTD 5M	94	112	5	3,6	2,1
LL-HTD 8M	135	163	8	6,0	3,5
LL-HTD 14M	240	330	14	10,0	6,0
LL-GT 3MR	53		3	2,4	1,1
LL-GT 5MR	94	112	5	3,8	1,9
LL-GT 8MR	135	185	8	5,8	3,3

Neoprene - Zahnflachriemen/ Meterware - endlich  
 Neoprene - Timing Belt - open ended

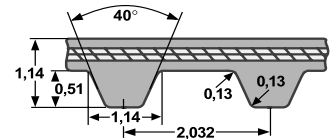

**Type MXL - Teilung/ Pitch 2,032 mm**

	Breite/width	Breite/width	Breite/width	Breite/width	Breite/width	Breite/width
mm	3,2	4,8	6,4	7,9	9,5	12,7
Zoll/ inch	012	019	025	031	037	050
	Meter	Meter	Meter	Meter	Meter	Meter
	Euro	Euro	Euro	Euro	Euro	Euro
	2,60	3,50	5,10	5,60	7,00	10,20

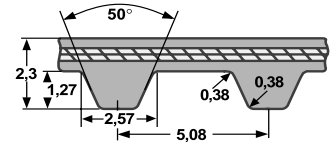

**Type XL - Teilung/ Pitch 5,08 mm**

	Breite/width	Breite/width	Breite/width	Breite/width	Breite/width
mm	6,4	7,9	9,5	12,7	19,05
Zoll/ inch	025	031	037	050	075
	Meter	Meter	Meter	Meter	Meter
	Euro	Euro	Euro	Euro	Euro
	4,20	5,20	6,10	8,30	12,40

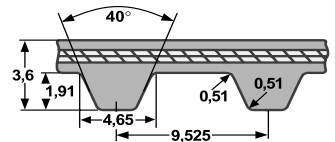

**Type L - Teilung/ Pitch 9,525 mm**

	Breite/width	Breite/width	Breite/width
mm	12,7	19,05	25,4
Zoll/ inch	050	075	100
	Meter	Meter	Meter
	Euro	Euro	Euro
	7,80	11,70	15,70

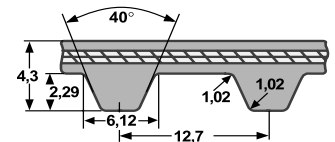

**Type H - Teilung/ Pitch 12,7 mm**

	Breite/width	Breite/width	Breite/width	Breite/width	Breite/width	Breite/width
mm	12,7	19,05	25,4	38,1	50,8	76,2
Zoll/ inch	050	075	100	150	200	300
	Meter	Meter	Meter	Meter	Meter	Meter
	Euro	Euro	Euro	Euro	Euro	Euro
	9,50	14,20	19,00	28,40	37,80	56,70

Rollenlänge auf Anfrage.

Aufpreis für Anschnitte: 10%

Length of rolls on request.

Surcharge for shorter lengths: 10%

**Polyurethan - Zahnflachriemen Flex  
mit endlos gefertigten Stahlzugträgern**  
**Polyurethane - Timing Belts Flex  
with endless steel cord**



**einfach gezahnt/ single toothed**

Teilung Pitch	T 5	T 10	T 20	AT 5	AT 10	AT 20	XL	L	H	XH	5M	8M	14M
------------------	-----	------	------	------	-------	-------	----	---	---	----	----	----	-----

Länge/ length: 1500 - 22 770 mm      Breite/ width: 6 - 150 mm

Preise auf Anfrage.      Prices on request.

**doppelt gezahnt/ double toothed**

Teilung Pitch	DT5	DT10	DT20	DAT5	DAT10	DAT20	DXL	DL	DH	DXH	D5M	D8M	D14M
------------------	-----	------	------	------	-------	-------	-----	----	----	-----	-----	-----	------

Länge/ length: 1500 - 22 770 mm      Mindestmenge/ minimum quantity: 150 mm

Preise auf Anfrage.      Prices on request.

**Neoprene - Endlose Hochleistungs - Flachriemen**  
**Neoprene - Endless High Capacity - Flat Belts**

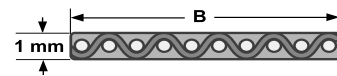

**Type 150: h = 1,0 mm**

Länge length	Breite width	Breite width	Breite width	Breite width	Breite width	Breite width	Breite width	Breite width	Breite width	Breite width	Breite width	Breite width	Breite width	Breite width
	10 mm	15 mm	20 mm	25 mm	30 mm	35 mm	40 mm	50 mm	60 mm	70 mm	80 mm	90 mm	100 mm	330 mm
	Stück piece Euro	Stück piece Euro	Stück piece Euro	Stück piece Euro	Stück piece Euro	Stück piece Euro	Stück piece Euro	Stück piece Euro	Stück piece Euro	Stück piece Euro	Stück piece Euro	Stück piece Euro	Stück piece Euro	Stück piece Euro
200-600	10,80	13,40	15,60	17,90	20,60	23,00	25,20	31,60	37,80	44,80	49,50	55,60	61,10	182,60
601-700	11,70	14,30	17,00	18,70	22,10	24,80	27,40	34,20	40,80	48,30	53,60	60,10	66,00	198,80
701-800	12,30	15,50	17,90	20,60	23,30	26,30	28,90	36,30	43,40	51,30	56,80	63,70	70,10	210,80
801-900	12,90	16,10	19,00	21,80	24,90	27,60	30,80	38,50	46,10	54,50	60,40	67,80	74,50	224,30
901-1000	13,80	17,10	20,30	23,30	26,40	29,50	32,70	40,80	48,80	57,60	63,80	71,50	78,80	236,30
1001-1200	15,60	19,00	22,60	26,10	29,20	33,10	36,30	45,50	54,50	64,40	71,40	80,10	88,00	264,50
1201-1400	17,20	21,00	25,00	28,60	32,50	36,30	40,00	50,10	59,90	70,80	78,50	88,00	96,70	290,10
1401-1600	18,70	23,00	26,90	31,30	35,30	39,50	43,90	54,90	65,80	77,70	86,40	96,70	106,30	318,30
1601-1800	20,30	24,90	29,20	33,80	38,00	42,90	47,50	59,00	70,60	83,20	92,90	103,90	114,20	342,50
1801-2000	21,80	26,50	31,60	36,50	42,60	46,20	51,30	63,80	76,40	90,40	99,80	112,60	123,70	370,70
2001-2200	23,30	28,60	33,80	39,10	44,40	48,80	54,80	68,80	82,40	96,70	107,90	120,60	132,40	398,90
2201-2400	25,00	30,50	36,10	41,80	47,30	53,00	58,40	73,30	88,00	103,90	115,00	128,50	142,40	425,70
2401-2600	26,40	32,60	38,20	44,10	50,40	56,30	62,30	77,90	93,60	110,30	122,30	137,00	150,30	452,60
2601-2800	28,20	34,00	40,80	47,00	53,20	59,80	65,90	82,40	99,20	116,60	129,30	145,00	159,70	479,30
2801-3000	29,50	36,30	43,10	49,50	56,30	63,10	69,90	83,20	99,80	118,20	135,10	146,40	161,10	483,40
3001-3200	31,30	38,10	45,30	52,30	59,70	66,30	73,20	92,00	109,40	130,10	143,60	161,10	177,20	531,70
3201-3400	32,70	40,20	47,80	54,80	62,50	69,90	77,30	96,10	115,00	137,00	150,30	169,20	185,30	557,30
3401-3600	33,80	42,30	50,00	57,30	65,40	73,10	80,90	101,60	121,40	143,60	158,50	177,20	196,00	586,80

Farbe/ colour: schwarz/ black

Im Längenabstand von 10 mm lieferbar.

Lengths in 10 mm distance available.

Weitere Längen auf Anfrage.

Further lengths on request.

## Polyurethan - Endlose Hochleistungs - Flachriemen Polyurethane - Endless High Capacity - Flat Belts

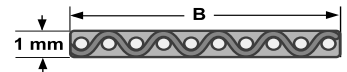

### Type P 5110

Länge length	Breite width	Breite width	Breite width	Breite width	Breite width	Breite width	Breite width	Breite width	Breite width	Breite width	Breite width	Breite width	Breite width	Breite width
	10 mm	15 mm	20 mm	25 mm	30 mm	35 mm	40 mm	45 mm	50 mm	60 mm	70 mm	80 mm	90 mm	100 mm
	Stück piece Euro	Stück piece Euro	Stück piece Euro	Stück piece Euro	Stück piece Euro	Stück piece Euro	Stück piece Euro	Stück piece Euro	Stück piece Euro	Stück piece Euro	Stück piece Euro	Stück piece Euro	Stück piece Euro	Stück piece Euro
300-399	10,30	12,90	15,50	17,90	20,50	23,10	25,40	28,10	30,60	35,50	40,70	45,80	50,70	55,90
400-499	10,60	13,30	16,10	18,70	21,60	24,20	26,90	29,50	32,40	37,80	43,30	48,50	53,90	59,50
500-590	10,80	13,80	16,60	19,60	22,30	25,30	28,20	31,00	33,90	39,70	45,50	51,30	56,90	62,70
600-699	11,20	14,40	17,40	20,60	23,40	26,50	29,60	32,60	35,90	41,90	48,10	54,30	60,40	66,70
700-799	11,70	14,70	18,10	21,60	25,30	28,10	31,10	34,70	37,90	45,00	50,70	57,30	63,90	70,40
800-899	11,90	15,50	18,70	22,10	25,60	29,10	32,50	36,00	39,20	46,20	53,00	59,90	66,80	73,50
900-999	12,20	16,00	19,60	23,10	26,60	30,50	33,10	36,80	41,20	48,40	55,70	63,00	70,20	77,40
1000-1099	12,50	16,30	20,00	23,80	27,50	31,30	35,00	38,60	42,50	50,00	57,40	65,00	72,40	80,00
1100-1199	12,90	16,80	20,70	24,80	28,60	32,50	36,50	40,50	44,20	52,20	60,00	68,10	75,70	83,60
1200-1299	13,30	17,40	21,40	25,60	29,50	33,90	38,00	42,00	46,20	54,40	62,70	71,10	79,20	87,60
1300-1399	13,40	17,70	22,00	26,30	30,60	34,90	39,10	43,30	47,80	56,00	64,70	73,20	81,80	90,30
1400-1499	13,80	18,50	23,00	27,30	31,70	36,30	40,70	45,20	49,60	58,70	67,50	76,50	85,70	94,40
1500-1599	14,20	18,70	23,80	28,00	32,50	37,00	41,70	46,70	50,70	59,90	69,00	78,40	87,40	96,60
1600-1699	14,40	19,20	24,50	28,60	33,30	38,00	42,70	47,50	52,20	61,50	71,10	80,50	89,90	99,40
1700-1799	14,60	19,60	25,40	29,50	34,60	39,20	44,10	49,10	53,80	63,90	73,50	83,40	93,20	103,00
1800-1899	15,10	20,30	26,20	30,60	35,70	40,80	45,90	51,20	56,00	66,50	76,50	86,90	96,90	107,30
1900-1999	15,60	20,80	26,40	31,60	36,90	41,90	47,30	52,60	57,90	68,80	79,20	89,90	100,50	111,20
2000-2099	15,70	20,90	26,90	31,80	37,50	42,50	48,10	53,40	58,80	69,60	80,30	91,10	101,90	112,80
2100-2199	16,00	21,40	28,00	33,60	38,00	43,30	49,10	54,30	60,00	71,10	81,90	93,00	103,90	115,00
2200-2299	16,40	22,00	28,00	33,60	39,20	44,90	50,60	56,30	62,20	73,50	84,90	96,30	107,90	119,30
2300-2399	16,50	22,10	25,60	33,90	39,60	45,10	51,20	56,70	62,70	74,40	85,80	97,50	109,00	120,60
2400-2499	17,00	23,00	29,10	35,00	40,90	46,90	52,80	58,80	65,00	76,90	88,90	100,80	112,90	125,00
2500-2599	17,10	23,30	29,60	35,40	41,50	47,80	53,50	59,80	65,90	77,80	90,30	102,60	114,90	127,00
2600-2699	17,40	23,70	30,30	36,00	42,30	48,80	54,90	61,10	67,40	79,90	92,20	104,90	117,30	129,90
2700-2799	17,70	24,40	31,50	37,40	43,60	49,90	56,50	62,70	69,10	82,10	95,00	107,90	120,70	133,40
2800-2899	18,10	25,00	32,20	38,10	44,90	51,50	58,10	64,70	71,30	84,70	98,10	111,30	124,70	137,90
2900-2999	18,60	25,90	33,10	39,00	46,10	52,60	59,70	66,10	71,90	86,90	100,60	114,20	128,00	141,80
3000-3099	19,00	26,10	33,70	40,00	47,00	54,30	61,20	68,20	75,10	89,30	103,10	117,30	131,40	145,50
3100-3199	19,30	26,90	34,40	40,80	48,10	55,40	62,70	69,60	77,10	91,60	105,80	120,30	134,80	149,10
3200-3299	19,80	27,30	35,30	42,00	49,50	57,00	64,60	71,90	79,30	94,10	109,00	123,80	138,80	153,80
3300-3399	20,30	28,10	36,40	43,10	50,60	58,40	65,90	73,50	80,90	96,30	111,40	126,80	141,90	157,20
3400-3499	20,80	28,70	37,00	44,10	52,20	59,90	67,70	75,50	83,20	98,80	114,50	130,10	145,70	161,50
3500-3599	21,40	29,40	38,00	45,30	53,40	61,50	69,20	77,30	85,20	101,30	117,20	133,20	149,20	165,30
3600-3699	22,00	25,60	39,20	46,80	55,10	63,20	71,50	79,90	87,90	104,60	121,00	137,50	154,10	170,60
3700-3799	22,60	31,30	40,30	48,00	56,50	65,00	73,50	81,90	90,80	107,30	124,30	141,20	158,20	175,10
3800-3899	23,30	32,20	41,70	49,50	58,40	67,20	75,70	84,60	93,20	110,80	128,20	145,80	163,40	180,90
3900-3999	24,00	33,20	42,90	51,20	60,10	69,20	78,40	87,30	95,80	114,20	132,40	150,60	168,70	186,70
4000-4099	24,90	34,20	44,10	52,70	62,10	71,50	80,60	90,10	98,20	117,80	136,40	155,00	173,80	192,50
4100-4199	25,40	35,20	45,50	54,30	63,90	73,70	83,00	92,90	100,70	121,40	140,50	159,50	179,00	198,20
4200-4299	26,20	36,30	46,90	55,90	65,70	75,70	85,20	95,60	103,10	124,90	144,60	164,30	184,10	204,00

Standardfarben: gelb oder grau

Verfügbarkeit auf Anfrage.

Standard colours: yellow or grey

Availability on request.

Im Längenabstand von 10 mm lieferbar.

Weitere Qualitäten auf Anfrage.

Lengths in 10 mm distance available.

Further qualities on request.

## Werkzeuge zum Endlosschweißen von Polyurethan Keil- und Rundriemen Tools for endless welding of Polyurethane V- and Round-Belt

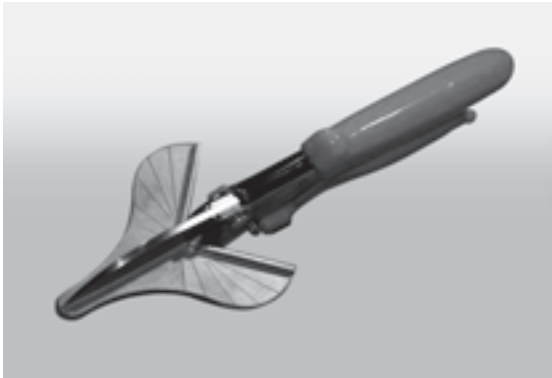

Gehrungsschere GS-25  
Cutter GS-25  
Euro 58,30



Handbohrer D-11  
mit drei Einsätzen, Gr. A, B, C  
Drill D-11  
includes bits A, B, C  
Euro 96,90



Führungszange F-51  
auch für Flachriemen bis 50 mm  
Pliers F-51  
also for flat belts up to 50 mm  
Euro 198,30

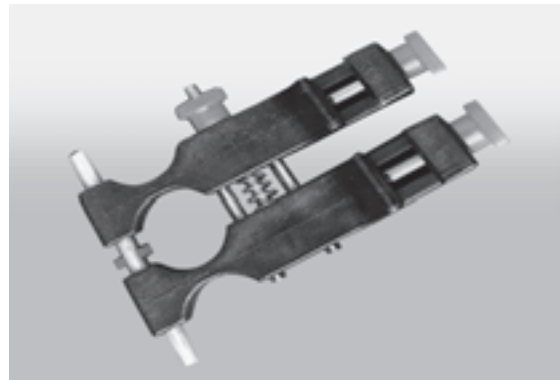

Miniführungszange R-8  
für Rundriemen bis 8 mm  
Mini pliers R-8  
for round belts up to 8 mm  
Euro 142,10



Schweißspiegel WU2  
Welder WU2  
Euro 211,40



Überlappungsverbindungssystem  
Preis auf Anfrage.  
Overlap splicing system  
Price on request.



Durchmesser Diameter mm	RPN grün / green 88 Shore A Meter Euro	RPS* grün / green 88 Shore A Meter Euro	RM rot / red 90 Shore A Meter Euro	RL / RLC*** braun / brown 80 Shore A Meter Euro	ROS* orange 83 Shore A Meter Euro	RO orange 83 Shore A Meter Euro	RMW* beige 95 Shore A Meter Euro	RCW* weiß / white 100 Shore A Meter Euro
2	0,60	–	1,00	1,00	–	–	–	–
3	1,00	–	1,10	1,10	–	1,00	–	–
4	1,20	–	1,20	1,20	–	1,30	–	–
5	1,60	2,10	1,60	1,60	–	1,60	–	–
6	2,20	3,00	–	2,30	–	–	–	–
6,3	–	–	2,60	2,60	3,40	2,50	3,80	3,80
7	2,90	3,50	–	–	–	–	–	–
8	3,70	4,40	4,20	4,20	5,10	3,90	6,00	–
9	4,90	6,50	–	–	–	–	–	–
9,5	–	–	5,60	5,60	6,70	5,20	8,00	7,50
10	5,70	7,30	–	6,80	–	–	–	–
12	7,50	10,20	–	–	–	–	–	–
12,5	–	–	9,30	9,30	11,50	8,80	13,50	13,50
14	–	–	–	–	14,50	11,40	–	–
15	10,70	15,90	13,40	13,40	16,60	12,70	19,50	–
18	17,90	21,90	20,60	20,60	0,00	–	29,90	–
19	–	–	–	–	25,50	19,40	–	–
20	21,00	–	21,90	–	–	–	–	–
25	–	–	–	41,30	–	41,30	–	–

Profil Section	VM rot / red 90 Shore A Meter Euro	VL braun / brown 80 Shore A Meter Euro	VH gelb / yellow 100 Shore A Meter Euro	VMW*/ ** beige 95 Shore A Meter Euro	VLW* blau / blue 80 Shore A Meter Euro	VO orange 83 Shore A Meter Euro	VM/ VL VH/ VO Supergrip Meter Euro	VMW/ VLW Supergrip Meter Euro
V- 8/M	4,50	4,50	4,50	–	–	4,50	–	–
V-10/Z	5,10	5,10	5,10	6,90	–	5,10	16,90	18,70
V-13/A	7,00	7,00	7,00	9,20	9,20	7,00	19,20	21,50
V-17/B	10,40	10,40	10,40	12,10	12,10	10,40	23,50	25,30
V -20	13,50	13,50	13,50	–	–	13,50	27,50	–
V-22/C	16,80	16,80	16,80	20,40	20,90	20,90	31,60	35,40
V-25	22,70	22,70	22,70	–	27,10	22,70	38,30	38,60
V-32/D	34,80	34,80	34,80	41,10	41,10	34,80	59,80	61,60
V-40/E	55,30	55,30	–	–	–	–	–	–

Profil Section	VL-RT braun / brown 80 Shore A Meter Euro	VM-RT rot / red 90 Shore A Meter Euro	VLW-RT* blau / blue 80 Shore A Meter Euro	YMF beige 90 Shore A Meter Euro
A/13	11,50	11,50	18,00	11,50
B/17	17,00	17,00	26,40	17,00
C/22	29,60	29,60	36,10	29,60

Technische Einzelheiten siehe Seite 111.

Technical details see page 111.

Profil Section	DVOS* orange 83 Shore A Meter Euro	VOS-GT* orange 83 Shore A Meter Euro	VO-GT orange 83 Shore A Meter Euro	VOS* orange 83 Shore A Meter Euro	DVL braun / brown 80 Shore A Meter Euro	DVO orange 83 Shore A Meter Euro	DVM rot / red 90 Shore A Meter Euro
10	–	–	–	6,50	13,00	13,10	–
A/13	23,80	–	–	9,10	18,00	18,00	18,00
B/17	–	12,20	10,40	12,00	–	–	–
C/22	–	19,90	16,80	–	–	–	–
D/32	–	41,40	–	–	–	–	–



Durchmesser Diameter	Hohlrundriemen Hollow Round Belts	Nippel Nipples	
mm	rot / red 85 Shore A Meter Euro		
4,8	2,70	1,00	Weitere Typen auf Anfrage. Further types on request.
6,3	3,10	1,00	
8	4,20	1,00	
9,5	5,60	1,20	
12,5	8,30	1,20	
15	11,40	1,30	
16	12,20	1,60	

\* zugträgerverstärkt

\* reinforced with cord

\*\* ab Profil 13/ A gezahnt

\*\* from section 13/ A toothed

\*\*\* transparent

\*\*\* clear

Rundriemen 2 mm      Rolle = 60 m

Rundriemen RCW      Rolle = 150 m



alle anderen      Rolle = 30 m











round belt 2 mm      roll = 60 m

round belt RCW      roll = 150 m









all others      roll = 30 m

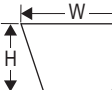





## Polyurethan Keil- und Rundriemen – technische Daten Polyurethane V- and Round-Belts – technical data

 Mindestscheibendurchmesser (mm)  
 Minimum Pulley Diameter (mm)  
 Zugkraft (kg) bei ... % Vorspannung  
 (Höhere Zugkraft bei höherer Vorspannung)  
 Pull Force (kg) at ... % Tension  
 (Higher Pull Force at higher Tension)

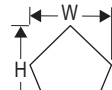
 Härte/Hardness Temperatur/Friction Stahl/Steel	RL / RLC***	RLW	RO	ROS	RPN	RPS	RM	RMW	RCW							
	 80 SHORE A -40°C bis/to 55°C 0.55 Ja/Yes	 80 SHORE A -40°C bis/to 55°C 0.55 Ja/Yes	 83 SHORE A -40°C bis/to 55°C 0.55 Ja/Yes	 83 SHORE A -40°C bis/to 55°C 0.55 Ja/Yes	 88 SHORE A -30°C bis/to 80°C 0.38 Nein/No	 88 SHORE A -30°C bis/to 80°C 0.40 Nein/No	 90 SHORE A -30°C bis/to 60°C 0.45 Ja/Yes	 95 SHORE A -30°C bis/to 60°C 0.36 Ja/Yes	 100 SHORE A -20°C bis/to 75°C 0.27 Ja/Yes							
Durchmesser (mm) Diameter (mm)	MIN	↔	MIN	↔	MIN	↔	MIN	↔	MIN	↔	MIN	↔	MIN	↔	MIN	↔
2	15	0.06			15	0.06			19	0.13			20	0.26		
3	20	0.14			20	0.14			29	0.31			30	0.60		
4	30	0.25			30	0.25			38	0.54			40	1.00		
5	35	0.40			34	0.40			48	0.85			50	1.60		
6									57	1.22						
6,3	40	0.60			38	0.68	42	4.5					60	2.60	75	20
7									67	1.67	70	18				
8	55	1.00			48	1.06	54	5	76	2.18	80	19	80	4.20	95	35
9									86	2.75	90	21				
9,5	65	1.40			57	1.54	64	9.5					95	5.90	110	37
10									95	3.40	100	22				
12									114	4.90	120	26				
12,5	85	2.50	90	18	75	2.75	86	11.4					125	10.10	150	57
14					84	3.43	95	12.3								
15	100	3.50			95	4.25	108	13.6	143	7.65	150	27	150	14.60	175	60
18	120	5.10	125	27					171	11.00	180	37	180	21.00	210	64
19					115	6.11	127	15								
20									190	13.60			200	25.90		
25					150	10.6										

### \* – VERFÜGBAR MIT SUPER GRIP / AVAILABLE WITH SUPER GRIP

 Härte/Hardness Temperatur/Friction Stahl/Steel FDA/USDA	VL*	VLW*	VO*	VOS*	VOS-GT	VM*	VMW*	VH								
	 80 SHORE A -40°C bis/to 55°C 0.55 Ja/Yes	 80 SHORE A -40°C bis/to 55°C 0.55 Ja/Yes	 83 SHORE A -40°C bis/to 55°C 0.55 Ja/Yes	 83 SHORE A -40°C bis/to 55°C 0.55 Ja/Yes	 83 SHORE A -40°C bis/to 55°C 0.55 Ja/Yes	 90 SHORE A -30°C bis/to 60°C 0.45 Ja/Yes	 95 SHORE A -30°C bis/to 60°C 0.36 Ja/Yes	 100 SHORE A -20°C bis/to 75°C 0.28 Ja/Yes								
Größe B x H (mm) Size W x H (mm)	MIN	↔	MIN	↔	MIN	↔	MIN	↔	MIN	↔	MIN	↔	MIN	↔	MIN	↔
8/M = 8 x 6.2	40	0.7			45	0.9			60	3.0			125	4.8		
10/Z = 10 x 6.5	45	1.0					40	5	65	4.1	75	25	130	6.6		
13/A = 13 x 8	50	1.6	50	12	50	1.6	53	12	80	6.7	75	28	160	10.7		
17/B = 17 x 11.5	75	2.9	75	18	75	2.9	72	17	115	12.1	100	55	230	19.5		
20 = 20 x 12.5	85	3.9							125	15.9			250	25.5		
22/C = 22 x 14.5	100	4.8	100	22	100	4.6		100	145	20.0	130	72	290	32.0		
25 = 25 x 16.5	110	6.3			100	4.6			165	25.9			330	41.5		
32/D = 32 x 21.5	145	10.4	145	43					140	25	215	43.0				

 Härte/Hardness Temperatur/Friction Stahl/Steel FDA/USDA	VL-RT	VM-RT	VLW-RT	YMF	DVL	DVO									
	 80 SHORE A -40°C bis/to 55°C 0.55 Ja/Yes	 90 SHORE A -30°C bis/to 60°C 0.45 Ja/Yes	 80 SHORE A -40°C bis/to 55°C 0.55 Ja/Yes	 90 SHORE A -30°C bis/to 60°C 0.45 Nein/No	 80 SHORE A -40°C bis/to 55°C 0.55 Ja/Yes	 83 SHORE A -40°C bis/to 55°C 0.55 Ja/Yes									
Größe B x H (mm) Size W x H (mm)	MIN	↔	MIN	↔	MIN	↔	MIN	↔	MIN	↔	MIN	↔	MIN	↔	
10/Z															
13/A = 13 x 16	110	2.7	160	11.0	A/13 = 13 x 16	110	16	A/13 = 13 x 15	150	10.0	Z/24 (9.5) x 6.8	45	2.0	45	2.0
17/B = 17 x 19.5	130	4.3	195	17.8	B/17 = 17 x 19.5	130	19	B/17 = 17 x 18.5	185	14.1	A/30 (13) x 8	50	3.2	50	3.2
22/C = 22 x 28.5	190	7.9	285	32.5	C/22 = 22 x 24.5	165	38	C/22 = 22 x 24.5	250	28.9					

auf Anfrage  
on request

